

CCD linear image sensor

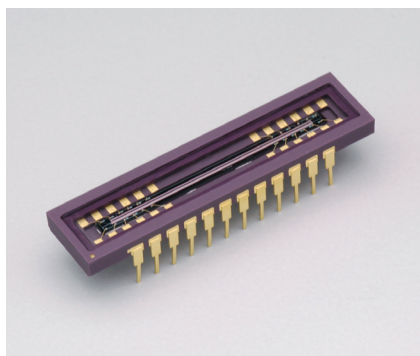

S11151-2048

High sensitivity in the ultraviolet region, front-illuminated CCD

Despite a front-illuminated CCD, the S11151-2048 offers high sensitivity in the ultraviolet region (200 nm) nearly equal to back-thinned CCD.

Features

- High sensitivity in the ultraviolet region (spectral response range: 200 to 1000 nm)
- Image lag: 0.1% typ.
- Low dark current
- Low cost

Applications

- Spectrometers

Structure

Parameter	Specification
Pixel size (H × V)	14 × 200 μm
Number of total pixels	2056
Number of effective pixels	2048
Image size (H × V)	28.672 × 0.200 mm
Horizontal clock phase	2-phase
Output circuit	Two-stage MOSFET source follower
Package	24-pin ceramic DIP (refer to dimensional outline)
Window material	Quartz glass*1

*1: Resin sealing

Absolute maximum ratings (Ta=25 °C, unless otherwise noted)

Parameter	Symbol	Min.	Typ.	Max.	Unit	
Operating temperature*2 *3	Topr	-50	-	+55	°C	
Storage temperature*3	Tstg	-50	-	+70	°C	
Output transistor drain voltage	VOD	-0.5	-	+25	V	
Reset drain voltage	VRD	-0.5	-	+18	V	
Test point	Vertical input source voltage	VISV	-0.5	-	+18	V
	Horizontal input source voltage	VISH	-0.5	-	+18	V
	Vertical input gate voltage	VIGV	-10	-	+15	V
	Horizontal input gate voltage	VIGH	-10	-	+15	V
Summing gate voltage	VSG	-10	-	+15	V	
Output gate voltage	VOG	-10	-	+15	V	
Reset gate voltage	VRG	-10	-	+15	V	
Transfer gate voltage	VTG	-10	-	+15	V	
Horizontal shift register clock voltage	VP1H, VP2H	-10	-	+15	V	

Note: Exceeding the absolute maximum ratings even momentarily may cause a drop in product quality. Always be sure to use the product within the absolute maximum ratings.

*2: Package temperature

*3: No dew condensation

When there is a temperature difference between a product and the surrounding area in high humidity environment, dew condensation may occur on the product surface. Dew condensation on the product may cause deterioration in characteristics and reliability.

Operating conditions (Ta=25 °C)

Parameter	Symbol	Min.	Typ.	Max.	Unit
Output transistor drain voltage	VOD	12	13	14	V
Reset drain voltage	VRD	10.5	11	11.5	V
Test point	Vertical input source voltage	VISV	-	VRD	V
	Horizontal input source voltage	VISH	-	VRD	V
	Vertical input gate voltage	VIGV	-5	-4	V
	Horizontal input gate voltage	VIGH	-5	-4	V
Summing gate voltage	High	VSGH	4	5	V
	Low	VSGL	-5	-4	
Output gate voltage	VOG	2	3	4	V
Substrate voltage	VSS	-	0	-	V
Reset gate voltage	High	VRGH	4	5	V
	Low	VRGL	-5	-4	
Transfer gate voltage	High	VTGH	7	8	V
	Low	VTGL	-5	-4	
Horizontal shift register clock voltage	High	VP1HH, VP2HH	4	5	V
	Low	VP1HL, VP2HL	-5	-4	
External load resistance	RL	2.0	2.2	2.4	kΩ

Electrical characteristics (Ta=25 °C, unless otherwise noted, operating conditions: Typ.)

Parameter	Symbol	Min.	Typ.	Max.	Unit
Signal output frequency*4	fc	-	1	5	MHz
Line rate	LR	-	0.48	2.37	kHz
Horizontal shift register capacitance	CP1H, CP2H	-	220	-	pF
Summing gate capacitance	CSG	-	10	-	pF
Reset gate capacitance	CRG	-	10	-	pF
Transfer gate capacitance	CTG	-	110	-	pF
Charge transfer efficiency*5	CTE	0.99995	0.99999	-	-
DC output level*4	Vout	-	8.5	-	V
Output impedance*4	Zo	-	220	-	Ω
Power consumption*4 *6	P	-	65	-	mW

*4: The value depends on the load resistance.

*5: Charge transfer efficiency per pixel of CCD shift register, measured at half of the full well capacity

*6: Power consumption of the on-chip amplifier plus load resistance

Electrical and optical characteristics (Ta=25 °C, unless otherwise noted, operating conditions: Typ.)

Parameter	Symbol	Min.	Typ.	Max.	Unit	
Saturation output voltage	Vsat	-	Fw × Sv	-	V	
Full well capacity	Fw	150	200	-	ke ⁻	
CCD node sensitivity	Sv	5	6	7	μV/e ⁻	
Dark current*7	Average of all effective pixels	DSave	-	700	3500	e ⁻ /pixel/s
			-	4	20	pA/cm ²
	Maximum of all effective pixels	DSmax	-	3500	17500	e ⁻ /pixel/s
			-	20	100	pA/cm ²
Readout noise*8	Nr	-	25	50	e ⁻ rms	
Dynamic range*9	DR	3000	8000	-	-	
Spectral response range	λ	-	200 to 1000	-	nm	
Photoresponse nonuniformity*10 *11	PRNU	-	±3	±10	%	
Image lag*10	L	-	0.1	1	%	

*7: Dark current is reduced to half for every 5 to 7 °C decrease in temperature.

*8: Readout frequency 1 MHz

*9: Dynamic range = Full well capacity / Readout noise

*10: Measured at one-half of the saturation output (full well capacity) using LED light (peak emission wavelength: 660 nm)

*11: Photoresponse nonuniformity = $\frac{\text{Fixed pattern noise (peak to peak)}}{\text{Signal}} \times 100$ [%]

▣ Spectral response (without window, typical example)*12

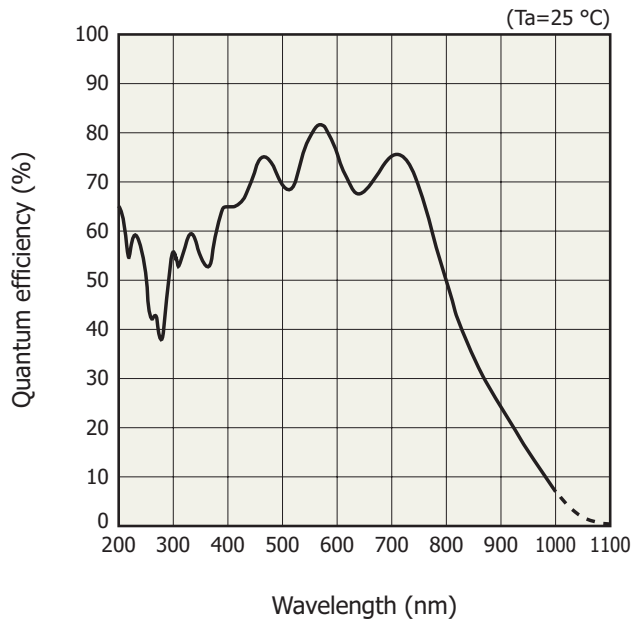

KMPDB0372EA

▣ Spectral transmittance characteristics of window material

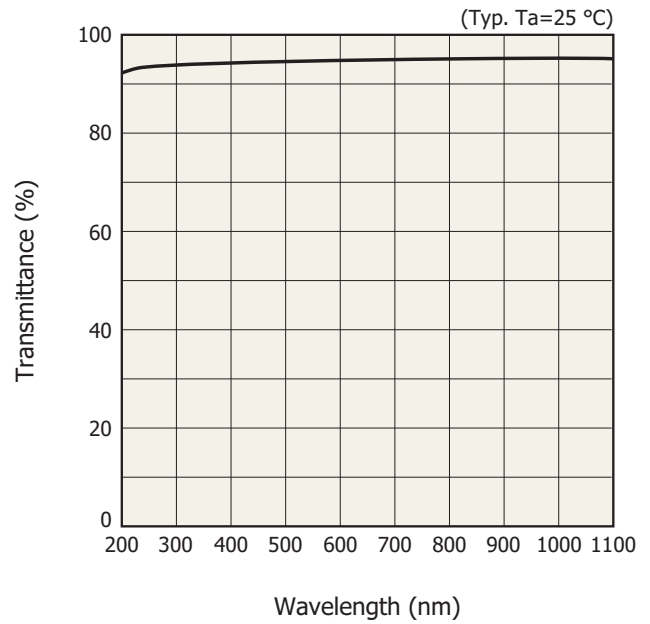

KMPDB0303EB

*12: Spectral response with quartz glass is decreased according to the spectral transmittance characteristic of window material.

▣ Device structure (conceptual drawing of top view)

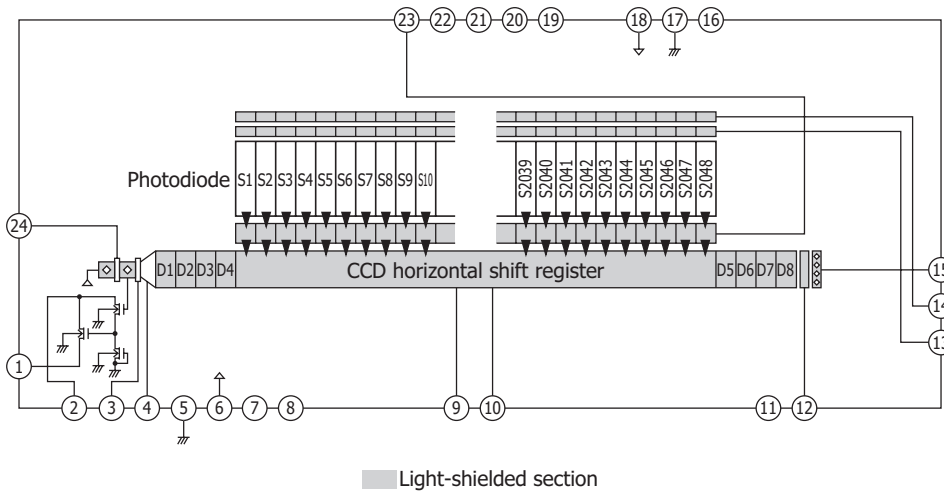

KMPDC0341EB

Timing chart

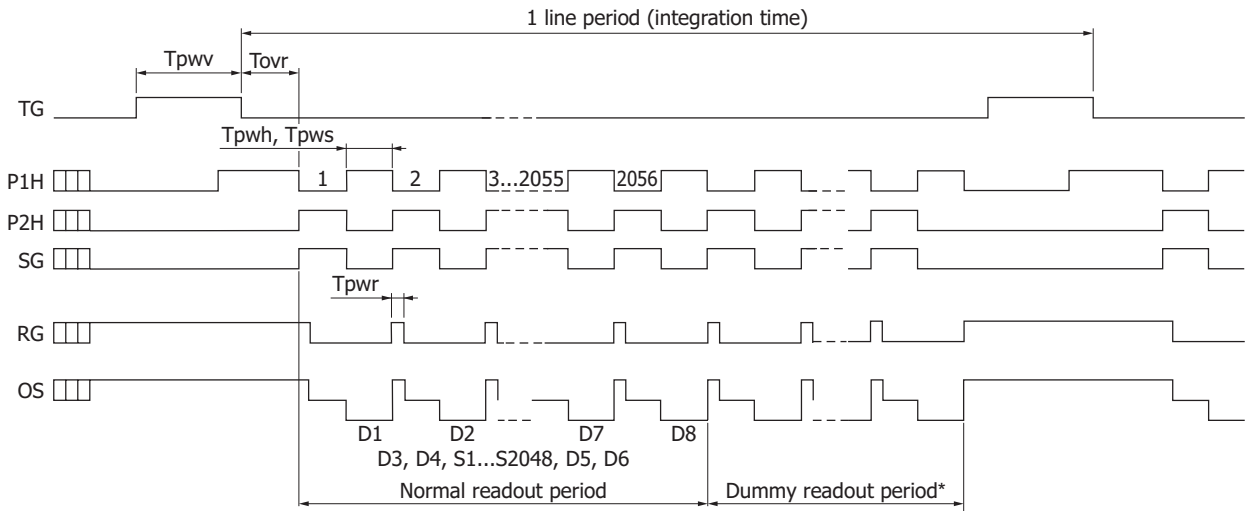

* When making the integration time longer than the normal readout period, to carry away the dark current generated in the CCD horizontal shift register, perform dummy readout after completion of the normal readout until right before rising transfer gate pulse.

KMPDC0342EC

Parameter		Symbol	Min.	Typ.	Max.	Unit
TG	Pulse width	T_{pwv}	6	8	-	μs
	Rise and fall times	T_{prv}, T_{pfv}	20	-	-	ns
P1H, P2H*13	Pulse width	T_{pwh}	100	500	-	ns
	Rise and fall times	T_{prh}, T_{pfh}	10	-	-	ns
	Duty ratio	-	40	50	60	%
SG	Pulse width	T_{pws}	100	500	-	ns
	Rise and fall times	T_{prs}, T_{pfs}	10	-	-	ns
	Duty ratio	-	40	50	60	%
RG	Pulse width	T_{pwr}	10	100	-	ns
	Rise and fall times	T_{prr}, T_{pfr}	5	-	-	ns
TG-P1H	Overlap time	T_{ovr}	1	2	-	μs

*13: Symmetrical clock pulses should be overlapped at 50% of maximum pulse amplitude.

Dimensional outline (unit: mm, tolerance unless otherwise noted: ±0.1)

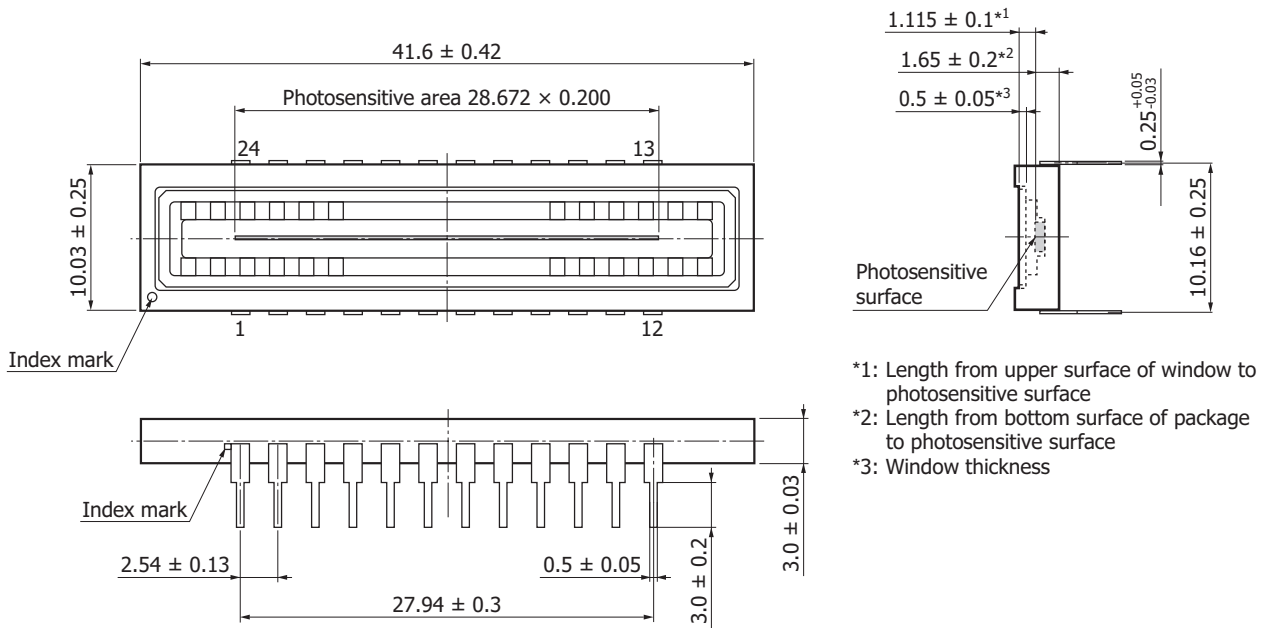

Note: This product is not hermetically sealed and moisture may penetrate inside the package. Avoid using or storing this product in an environment where sudden temperature and humidity changes may occur and cause condensation in the package.

KMPDA0261EC

Pin connections

Pin no.	Symbol	Function	Remark (standard operation)
1	OS	Output transistor source	R _L =2.2 kΩ
2	OD	Output transistor drain	+13 V
3	OG	Output gate	+3 V
4	SG	Summing gate	Same pulse as P2H
5	SS	Substrate	GND
6	RD	Reset drain	+11 V
7	-		
8	-		
9	P2H	CCD horizontal register clock-2	+5/-4 V
10	P1H	CCD horizontal register clock-1	+5/-4 V
11	-		
12	IGH	Test point (horizontal input gate)	-4 V
13	IGV	Test point (vertical input gate)	-4 V
14	ISV	Test point (vertical input source)	Connect it to RD.
15	ISH	Test point (horizontal input source)	Connect it to RD.
16	-		
17	SS	Substrate	GND
18	RD	Reset drain	+11 V
19	-		
20	-		
21	-		
22	-		
23	TG	Transfer gate	+8/-4 V
24	RG	Reset gate	+5/-4 V

Precautions

Electrostatic countermeasures

- Handle these sensors with bare hands or wearing cotton gloves. In addition, wear anti-static clothing or use a wrist band with an earth ring, in order to prevent electrostatic damage due to electrical charges from friction.
- Avoid directly placing these sensors on a work-desk or work-bench that may carry an electrostatic charge.
- Provide ground lines or ground connection with the work-floor, work-desk and work-bench to allow static electricity to discharge.
- Ground the tools used to handle these sensors, such as tweezers and soldering irons.

It is not always necessary to provide all the electrostatic measures stated above. Implement these measures according to the amount of damage that occurs.

When UV light irradiation is applied

When UV light irradiation is applied, the product characteristics may degrade. Such examples include degradation of the product's UV sensitivity and increase in dark current. This phenomenon varies depending on the irradiation level, irradiation intensity, usage time, and ambient environment and also varies depending on the product model. Before employing the product, we recommend that you check the tolerance under the ultraviolet light environment that the product will be used in.

Related information

www.hamamatsu.com/sp/ssd/doc_en.html

Precautions

- Disclaimer
- Image sensors

Driver circuit for CCD linear image sensor (S11151-2048) C11160 [sold separately]

The C11160 is a driver circuit designed for HAMAMATSU CCD linear image sensors S11151-2048. The C11160 can be used in spectrometers, etc. when combined with the CCD linear image sensor.

Features

- **Built-in 16-bit A/D converter**
- **Interface to computer: USB 2.0**
- **Power supply: USB bus power operation**

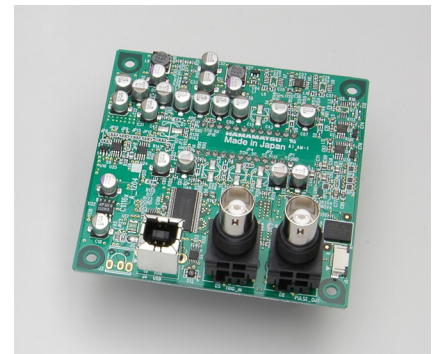

Information described in this material is current as of February 2017.

Product specifications are subject to change without prior notice due to improvements or other reasons. This document has been carefully prepared and the information contained is believed to be accurate. In rare cases, however, there may be inaccuracies such as text errors. Before using these products, always contact us for the delivery specification sheet to check the latest specifications.

The product warranty is valid for one year after delivery and is limited to product repair or replacement for defects discovered and reported to us within that one year period. However, even if within the warranty period we accept absolutely no liability for any loss caused by natural disasters or improper product use. Copying or reprinting the contents described in this material in whole or in part is prohibited without our prior permission.

HAMAMATSU

www.hamamatsu.com

HAMAMATSU PHOTONICS K.K., Solid State Division

1126-1 Ichino-cho, Higashi-ku, Hamamatsu City, 435-8558 Japan, Telephone: (81) 53-434-3311, Fax: (81) 53-434-5184

U.S.A.: Hamamatsu Corporation: 360 Foothill Road, Bridgewater, N.J. 08807, U.S.A., Telephone: (1) 908-231-0960, Fax: (1) 908-231-1218

Germany: Hamamatsu Photonics Deutschland GmbH: Arzbergerstr. 10, D-82211 Herrsching am Ammersee, Germany, Telephone: (49) 8152-375-0, Fax: (49) 8152-265-8

France: Hamamatsu Photonics France S.A.R.L.: 19, Rue du Saule Trapu, Parc du Moulin de Massy, 91882 Massy Cedex, France, Telephone: 33-(1) 69 53 71 00, Fax: 33-(1) 69 53 71 10

United Kingdom: Hamamatsu Photonics UK Limited: 2 Howard Court, 10 Tewin Road, Welwyn Garden City, Hertfordshire AL7 1BW, United Kingdom, Telephone: (44) 1707-294888, Fax: (44) 1707-325777

North Europe: Hamamatsu Photonics Norden AB: Torshamnsgatan 35 16440 Kista, Sweden, Telephone: (46) 8-509-031-00, Fax: (46) 8-509-031-01

Italy: Hamamatsu Photonics Italia S.r.l.: Strada della Moia, 1 int. 6, 20020 Arese (Milano), Italy, Telephone: (39) 02-93581733, Fax: (39) 02-93581741

China: Hamamatsu Photonics (China) Co., Ltd.: B1201, Jiaming Center, No.27 Dongsanhuan Beilu, Chaoyang District, Beijing 100020, China, Telephone: (86) 10-6586-6006, Fax: (86) 10-6586-2866