

TOSHIBA CCD Linear Image Sensor CCD (Charge Coupled Device)

**TCD2565BFG**

TOSHIBA CCD Linear Image Sensor CCD (Charge Coupled Device)

## TCD2565BFG

The TCD2565BFG is a high sensitive and low dark current 5400 elements × 3 lines output CCD color linear image sensor with 5400 elements × 1 line output CCD B/W linear image sensor.

The device contains a row of 5400 elements × 4 lines photodiodes which provide 24 lines/mm across a A4 size paper. The device is operated by 5.0 V pulse and 10 V power supply.

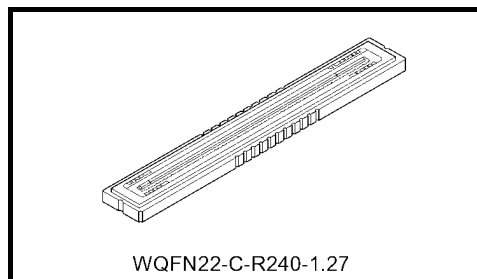

### Features

- Number of Image Sensing Elements: 5400 elements × 3 lines for Color  
5400 elements × 1 line for B/W
- Image Sensing Element Size: 5.25 μm by 5.25 μm on 5.25 μm center for Color  
5.25 μm by 5.25 μm on 5.25 μm center for B/W
- Photo Sensing Region: High sensitive PN photodiode
- Clock: 2-phase (5 V)
- Power Supply Voltage: 10 V (typ.)
- Distance between Photodiode Array: 10.5 μm (2 lines) B array – G array, G array – R array  
31.5 μm (6 lines) R array – B/W array
- Internal Circuit: Clamp circuit
- Package: 22 pin CLCC
- Color Filter: Red, Green, Blue

### ABSOLUTE MAXIMUM RATINGS (Note 1)

Characteristics	Symbol	Rating	Unit
Clock pulse voltage	$V_{\phi A}$	-0.3 to +8.0	V
Last stage clock pulse voltage	$V_{\phi B}$		
Shift pulse voltage	$V_{SH}$		
Reset pulse voltage	$V_{RS}$		
Clamp pulse voltage	$V_{CP}$		
Transfer pulse voltage	$V_{TG}$		
Switch pulse voltage	$V_{SW}$		
Power supply voltage	$V_{OD}$	-0.3 to +13.5	V
Operating temperature	$T_{opr}$	0 to 60	°C
Storage temperature	$T_{stg}$	-25 to +85	°C

Note 1: All voltages are with respect to SS terminals (ground).  
None of the ABSOLUTE MAXIMUM RATINGS must be exceeded, even instantaneously.  
If any one of the ABSOLUTE MAXIMUM RATINGS is exceeded, the electrical characteristics, reliability and life time of the device cannot be guaranteed. If the ABSOLUTE MAXIMUM RATINGS are exceeded, the device can be permanently damaged or degraded.  
Create a system design in such a manner that any of the ABSOLUTE MAXIMUM RATINGS will not be exceeded under any circumstances.

### Pin Connections (top view)

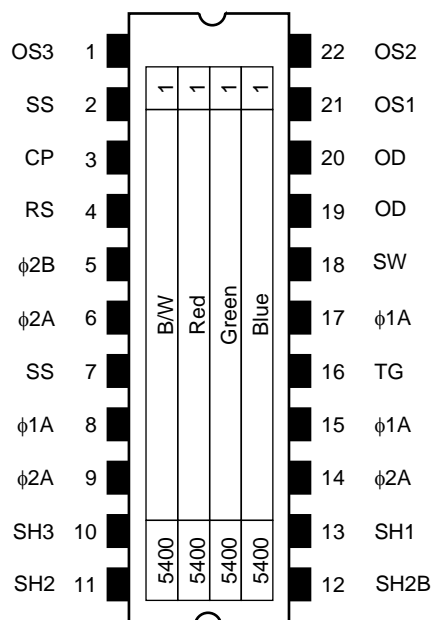

### Circuit Diagram

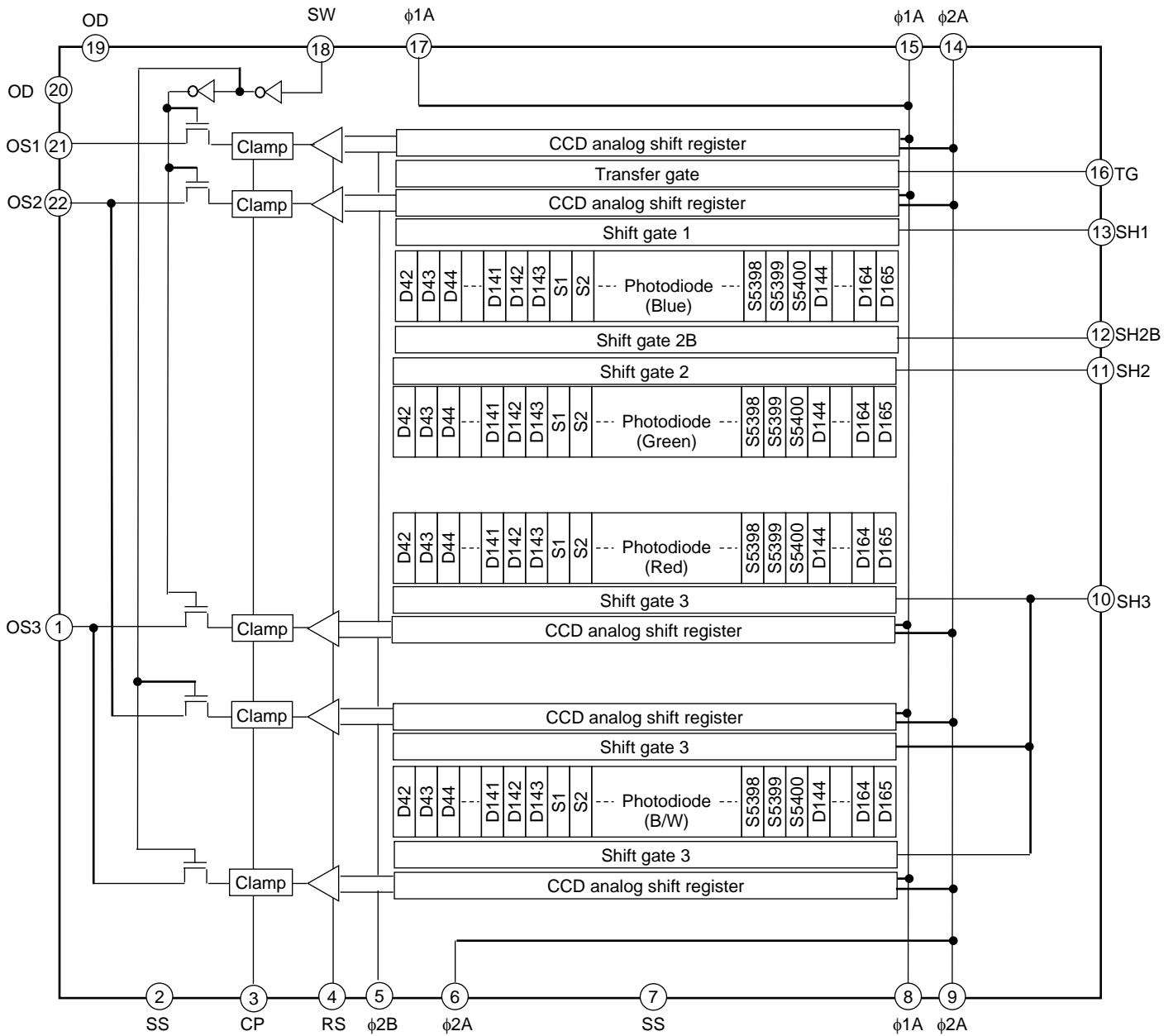

## Pin Names

Pin No.	Symbol	Name	Pin No.	Symbol	Name
1	OS3	Output signal 3 (Red or B/W(Even))	22	OS2	Output signal 2 (Green or B/W(Odd))
2	SS	Ground	21	OS1	Output signal 1 (Blue)
3	CP	Clamp gate	20	OD	Power supply
4	RS	Reset gate	19	OD	Power supply
5	$\phi$ 2B	Last stage transfer clock (phase 2)	18	SW	Switch gate for color or B/W
6	$\phi$ 2A	Transfer clock (phase 2)	17	$\phi$ 1A	Transfer clock (phase 1)
7	SS	Ground	16	TG	Transfer gate
8	$\phi$ 1A	Transfer clock (phase 1)	15	$\phi$ 1A	Transfer clock (phase 1)
9	$\phi$ 2A	Transfer clock (phase 2)	14	$\phi$ 2A	Transfer clock (phase 2)
10	SH3	Shift gate 3	13	SH1	Shift gate 1
11	SH2	Shift gate 2	12	SH2B	Shift gate 2B

### Optical/Electrical Characteristics 1

Ta = 25°C, VOD = 10 V, VSW = 5 V, Vφ = VSH = VRS = VCP = VTG = 5 V (pulse), fφ = 1.0 MHz, tINT (integration time) = 10 ms, light source = A light source + CM500S (t = 1.0 mm)

Characteristics		Symbol	Min	Typ.	Max	Unit	Note
Sensitivity	Red	RR	7.1	10.2	13.3	V/lx-s	(Note 2)
	Green	RG	6.4	9.2	12.0		
	Blue	RB	2.8	4.0	5.2		
Photo response non uniformity		PRNU (1)	—	10	20	%	(Note 3)
		PRNU (3)	—	3	12	mV	(Note 4)
Saturation output voltage		VSAT	1.5	2.0	—	V	(Note 5)
Saturation exposure		SE	0.12	0.21	—	lx-s	(Note 6)
Dark signal voltage		VDRK	—	1	6	mV	(Note 7)
Dark signal non uniformity		DSNU	—	6	12	mV	(Note 8)
DC power dissipation		PD	—	450	550	mW	—
Total transfer efficiency		TTE	92	98	—	%	—
Output impedance		ZO	—	0.2	0.5	kΩ	—
DC output signal voltage		VOS	4.0	5.0	6.0	V	(Note 9)
Random noise		NDσ	—	0.8	—	mV	(Note 10)

### Optical/Electrical Characteristics 2

Ta = 25°C, VOD = 10 V, VSW = 0 V, Vφ = VSH = VRS = VCP = VTG = 5 V (pulse), fφ = 1.0 MHz, tINT (integration time) = 10 ms, light source = A light source + CM500S (t = 1.0 mm)

Characteristics		Symbol	Min	Typ.	Max	Unit	Note
Sensitivity	B/W	RB/W	11.7	14.7	17.6	V/lx-s	(Note 2)
Photo response non uniformity		PRNU (1)	—	10	20	%	(Note 3)
		PRNU (3)	—	3	12	mV	(Note 4)
Saturation output voltage		VSAT	1.5	2.0	—	V	(Note 5)
Saturation exposure		SE	0.08	0.13	—	lx-s	(Note 6)
Dark signal voltage		VDRK	—	1	6	mV	(Note 7)
Dark signal non uniformity		DSNU	—	6	12	mV	(Note 8)
DC power dissipation		PD	—	430	550	mW	—
Total transfer efficiency		TTE	92	98	—	%	—
Output impedance		ZO	—	0.2	0.5	kΩ	—
DC output signal voltage		VOS	4.0	5.0	6.0	V	(Note 9)
Random noise		NDσ	—	0.6	—	mV	(Note 10)

Note 2: Sensitivity is defined for each color of signal outputs average when the photosensitive surface is applied with the light of uniform illumination and uniform color temperature.

Note 3: PRNU (1) is defined for each color on a single chip by the expressions below when the photosensitive surface is applied with the light of uniform illumination and uniform color temperature, where measured approximately 750 mV of signal output.

$$\text{PRNU (1)} = \frac{\Delta X}{\bar{X}} \times 100 (\%)$$

$\bar{X}$ : Average of total signal outputs  
 $\Delta X$ : The maximum deviation from  $\bar{X}$

Note 4: PRNU (3) is defined as the maximum voltage with next pixel, where measured approximately 50 mV of signal output.

Note 5: VSAT is defined as the minimum saturation output voltage of all effective pixels.

Note 6: Definition of SE:

$$\text{SE(Color)} = \frac{\text{VSAT}}{\text{RG}} \quad \text{SE(B/W)} = \frac{\text{VSAT}}{\text{RB/W}}$$

Note 7: VDRK is defined as average dark signal voltage of all effective pixels.

Note 8: DSNU is defined by the difference between average value (VDRK) and the maximum value of the dark voltage.

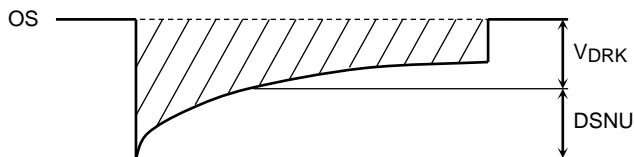

Note 9: DC output signal voltage is defined as follows.

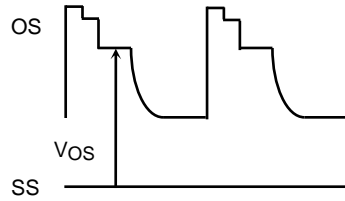

Note 10: Random noise is defined as the standard deviation (sigma) of the output level difference between two adjacent effective pixels under no illumination (i.e. dark condition) calculated by the following procedure.

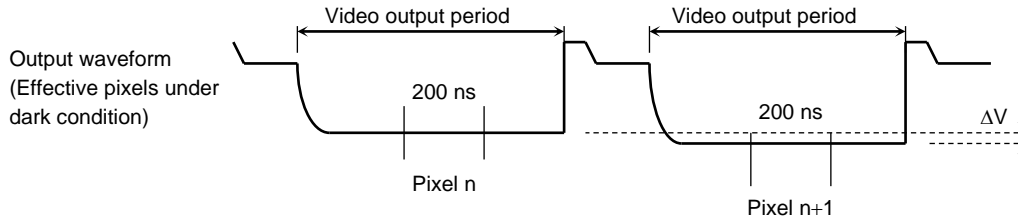

- 1) Two adjacent pixels (pixel n and n+1) in one reading are fixed as measurement points.
- 2) Each of the output levels at video output periods averaged over 200 ns period to get V(n) and V(n+1).
- 3) V(n+1) is subtracted from V(n) to get ΔV.  

$$\Delta V = V(n) - V(n+1)$$
- 4) The standard deviation of ΔV is calculated after procedure 2) and 3) are repeated 30 times (30 readings).

$$\overline{\Delta V} = \frac{1}{30} \sum_{i=1}^{30} |\Delta V_i| \quad \sigma = \sqrt{\frac{1}{30} \sum_{i=1}^{30} (|\Delta V_i| - \overline{\Delta V})^2}$$

- 5) Procedure 2), 3) and 4) are repeated 10 times to get sigma value.
- 6) 10 sigma values are averaged.  

$$\overline{\sigma} = \frac{1}{10} \sum_{j=1}^{10} \sigma_j$$
- 7)  $\overline{\sigma}$  value calculated using the above procedure is observed  $\sqrt{2}$  times larger than that measured relative to the ground level. So we specify the random noise as follows.

$$ND_{\sigma} = \frac{1}{\sqrt{2}} \overline{\sigma}$$

## Recommended Operating Conditions (Ta = 25°C)

For best performance, the device should be used within the Recommended Operating Conditions.

Characteristics		Symbol	Min	Typ.	Max	Unit
Clock pulse voltage	"H" level	$V_{\phi 1A}$	4.75	5.0	5.5	V
	"L" level	$V_{\phi 2A}$	0	0	0.25	
Last stage clock pulse voltage	"H" level	$V_{\phi 2B}$	4.75	5.0	5.5	V
	"L" level		0	0	0.25	
Shift pulse voltage	"H" level	$V_{SH}$	4.75	5.0	5.5	V
	"L" level		0	0	0.25	
Reset pulse voltage	"H" level	$V_{RS}$	4.75	5.0	5.5	V
	"L" level		0	0	0.25	
Clamp pulse voltage	"H" level	$V_{CP}$	4.75	5.0	5.5	V
	"L" level		0	0	0.25	
Transfer pulse voltage	"H" level	$V_{TG}$	4.75	5.0	5.5	V
	"L" level		0	0	0.25	
Switch pulse voltage	"H" level	$V_{SW}$	4.75	5.0	5.5	V
	"L" level		0	0	0.25	
Power supply voltage		$V_{OD}$	9.5	10.0	10.5	V

## Clock Characteristics (Ta = 25°C)

For best performance, the device should be used within the Recommended Operating Conditions.

Characteristics	Symbol	Min	Typ.	Max	Unit
Clock pulse frequency	$f_{\phi}$	0.5	1.0	35.0	MHz
Reset pulse frequency	$f_{RS}$	0.5	1.0	35.0	MHz
Clamp pulse frequency	$f_{CP}$	0.5	1.0	35.0	MHz
Clock capacitance (Note 11)	$C_{\phi A}$	—	80	—	pF
Last stage clock capacitance	$C_{\phi B}$	—	10	—	pF
Shift gate capacitance (Note 11)	$C_{SH}$	—	20	—	pF
Reset gate capacitance	$C_{RS}$	—	10	—	pF
Clamp gate capacitance	$C_{CP}$	—	10	—	pF
Transfer gate capacitance	$C_{TG}$	—	10	—	pF
Switch gate capacitance	$C_{SW}$	—	10	—	pF

Note 11:  $V_{OD} = 10\text{ V}$ , Input capacitance per a pin.

## Select Mode of B/W and Color

Mode	SW input pulse
Color	"H"
B/W	"L"



Timing Chart 1: Color Mode (Refer to the Timing Chart 2)

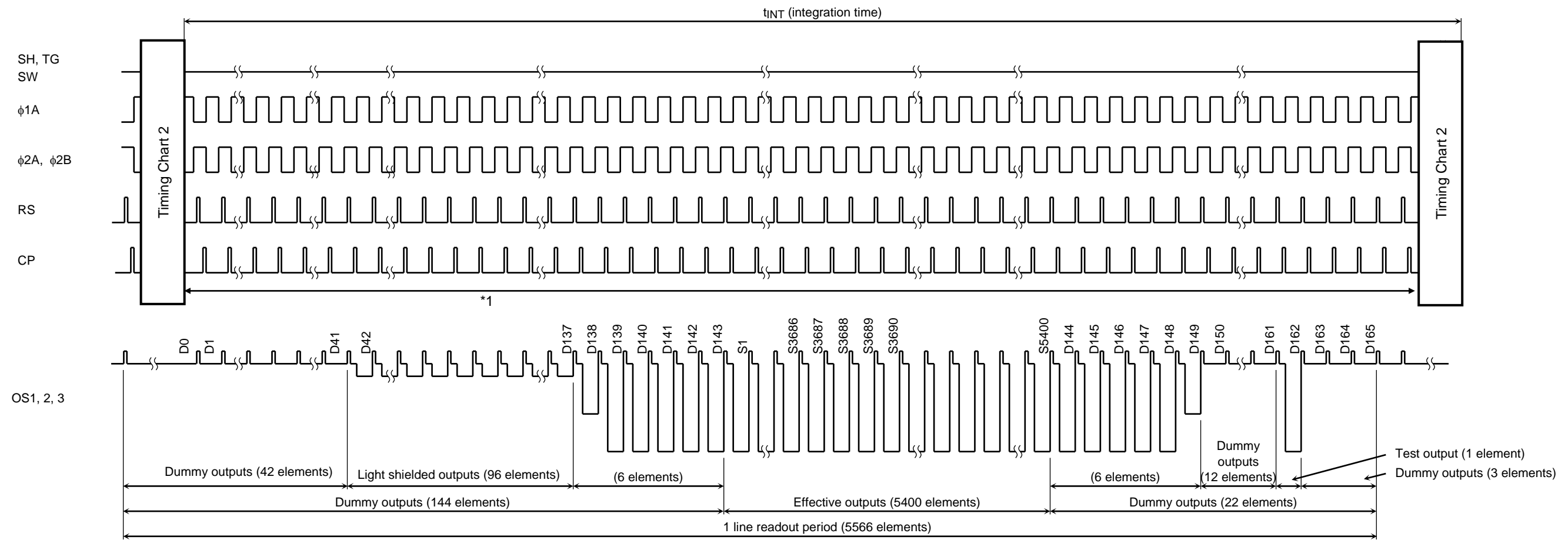

\*1: Keep the SH and TG pins "L" level and keep the SW pin "H" level.

Timing Chart 2: Color Mode (Vertical Transfer Period)

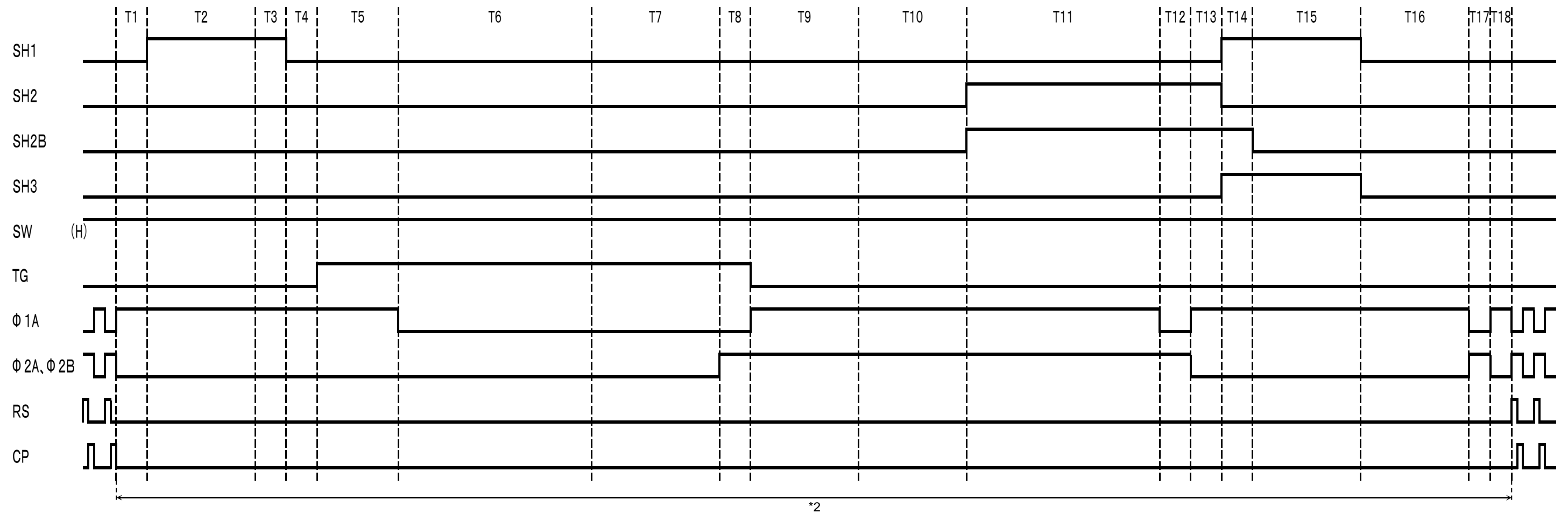

\*2: Keep the RS and CP pins "L" level.

Timing Chart 3: B/W Mode (Refer to the Timing Chart 4)

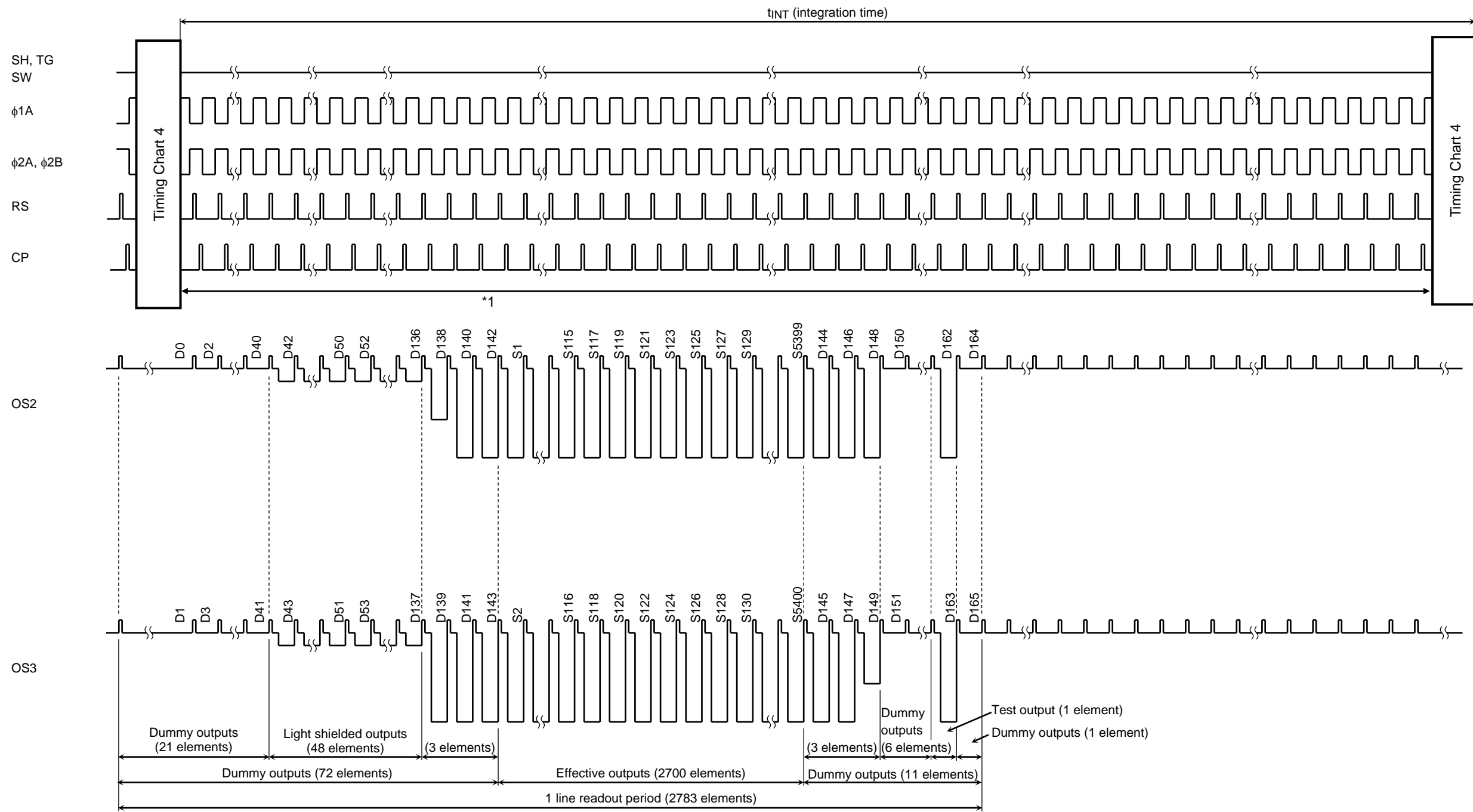

\*1: Keep the SH, TG and SW pins "L" level.

Timing Chart 4: B/W Mode (Vertical Transfer Period)

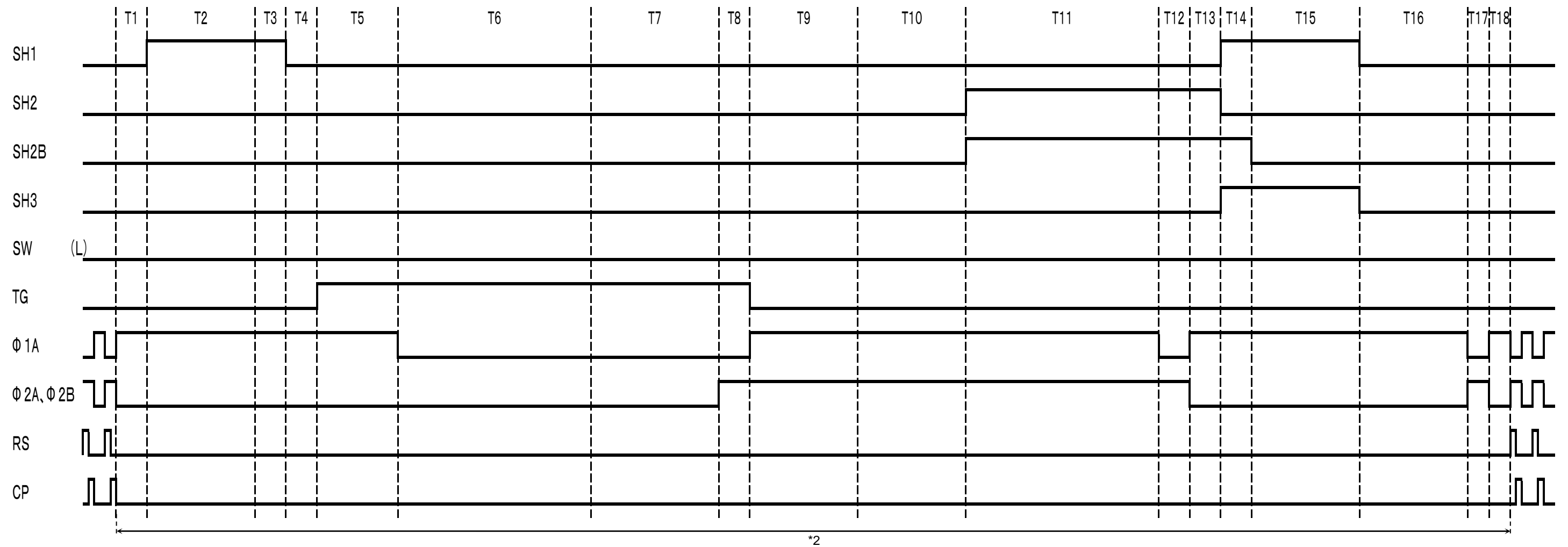

\*2: Keep the RS and CP pins "L" level.

## Timing Requirements 1

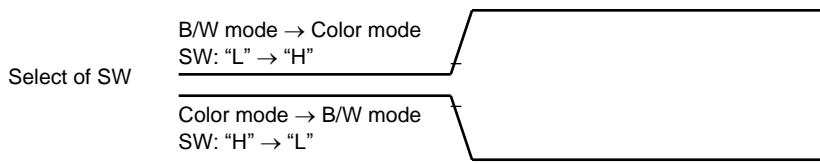

Note 12: Please scan the dummy more than 4 lines after the change of the mode.

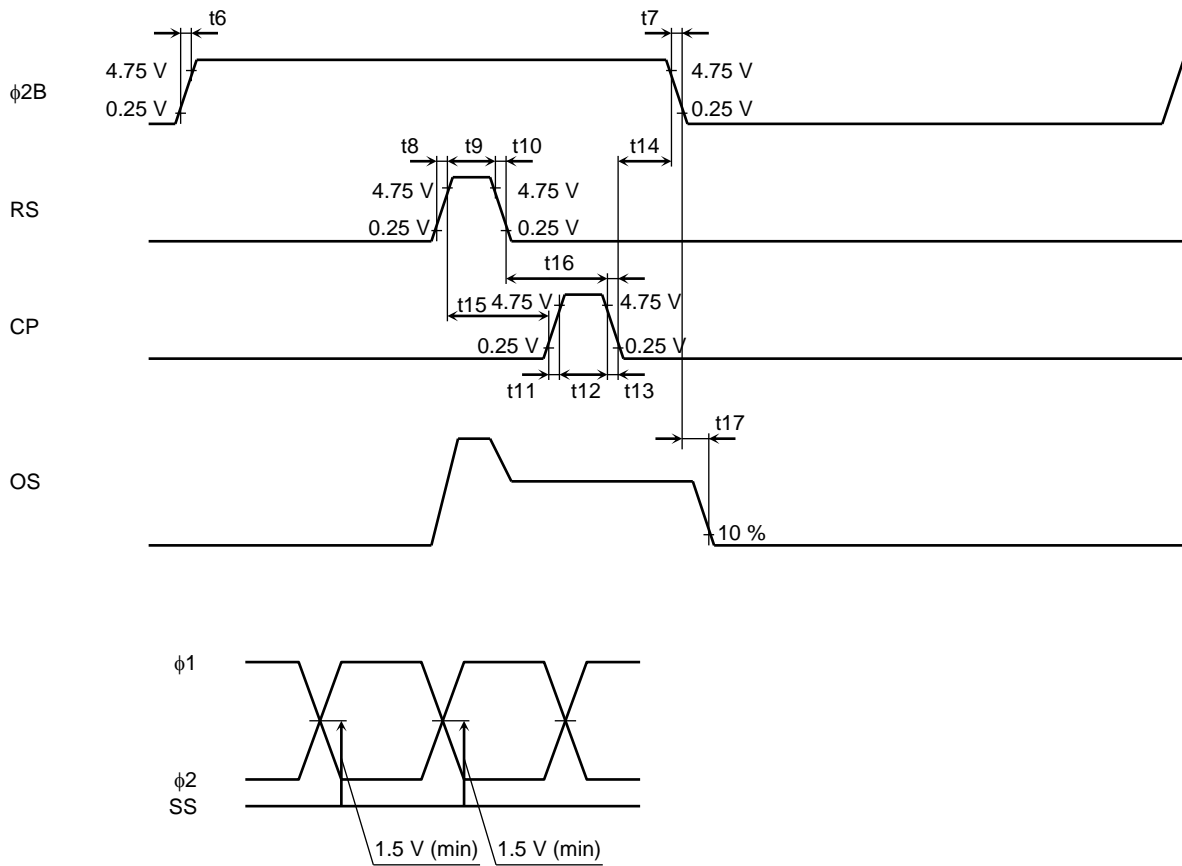

Characteristics	Symbol	Min	Typ. (Note 13)	Max	Unit
$\phi$ 2B pulse rise time, fall time	t6, t7	0	50	—	ns
RS pulse rise time, fall time	t8, t10	0	20	—	ns
RS pulse width	t9	6	100	—	ns
CP pulse rise time, fall time	t11, t13	0	20	—	ns
CP pulse width	t12	6	200	—	ns
Pulse timing of $\phi$ 2B and CP	t14	0	40	—	ns
Pulse timing of RS and CP	t15	0	0	—	ns
	t16	6	100	—	ns
Video data delay time	t17	—	7	—	ns

Note 13: Measured with  $f_{RS} = 1$  MHz.

### Timing Requirements 2 (Vertical Transfer Period)

Timing address	Min	Typ.	Max	Unit
T1	100	200	—	ns
T2	500	1000	—	ns
T3	100	200	—	ns
T4	100	200	—	ns
T5	400	800	—	ns
T6	1000	2000	—	ns
T7	600	1200	—	ns
T8	100	200	—	ns
T9	500	1000	—	ns
T10	500	1000	—	ns
T11	1000	2000	—	ns
T12	100	200	—	ns
T13	100	200	—	ns
T14	100	200	—	ns
T15	500	1000	—	ns
T16	500	1000	—	ns
T17	50	100	—	ns
T18	50	100	—	ns
Vertical transfer time	6.3	12.6	—	$\mu$ s

## Typical Spectral Response

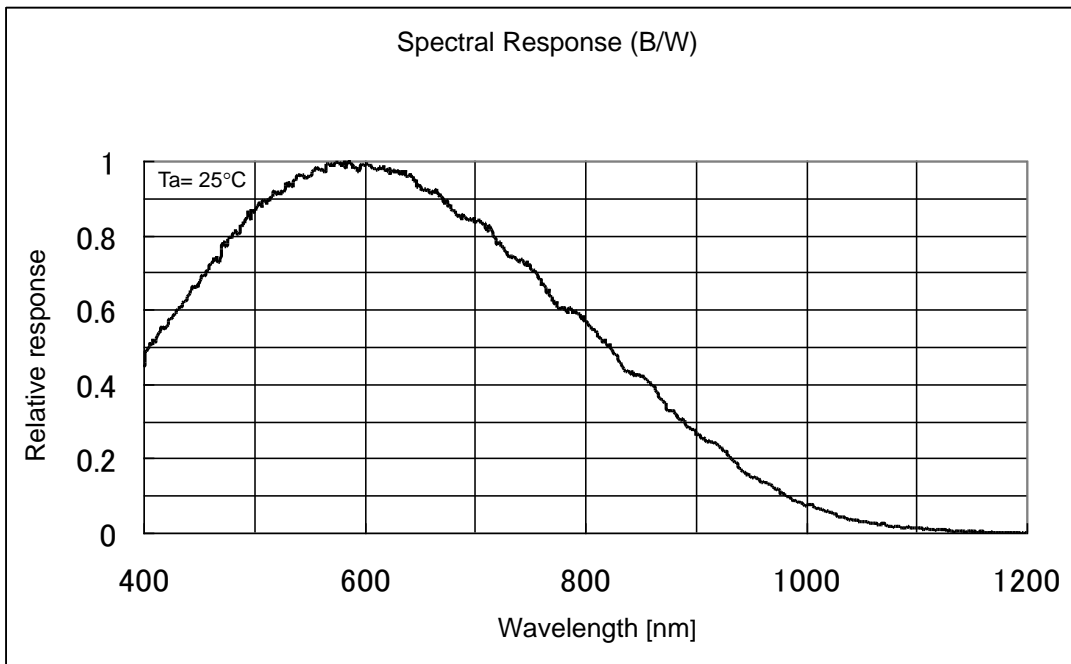
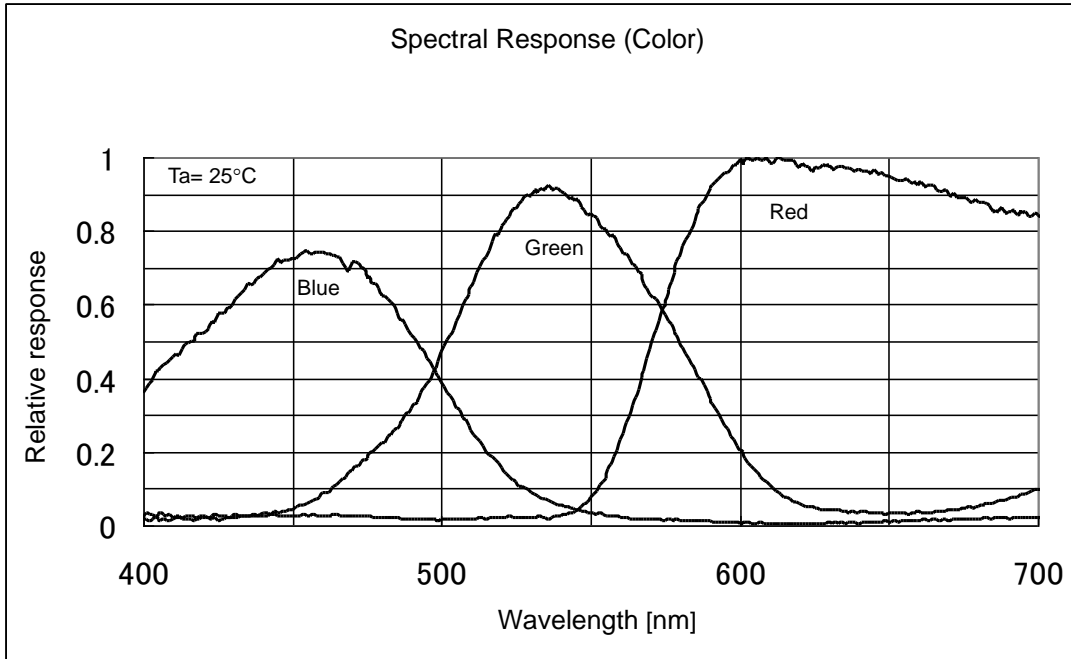

## Cautions

### 1. Electrostatic Breakdown

Store in shorting clip or in conductive foam to avoid electrostatic breakdown.

CCD Image Sensor is protected against static electricity, but inferior puncture mode device due to static electricity is sometimes detected. In handling the device, it is necessary to execute the following static electricity preventive measures, in order to prevent the trouble rate increase of the manufacturing system due to static electricity.

- a. Prevent the generation of static electricity due to friction by making the work with bare hands or by putting on cotton gloves and non-charging working clothes.
- b. Discharge the static electricity by providing earth plate or earth wire on the floor, door or stand of the work room.
- c. Ground the tools such as soldering iron, radio cutting pliers or pincer.
- d. Ionized air is recommended for discharge when handling CCD image sensors.

It is not necessarily required to execute all precaution items for static electricity.

It is all right to mitigate the precautions by confirming that the trouble rate within the prescribed range.

### 2. Incident Light

CCD sensor is sensitive to infrared light. Note that infrared light component degrades resolution and PRNU of CCD sensor.

### 3. Cloudiness of Glass Inside

CCD surface mount products may have a haze on the inside of glass, so be careful about following.

Even if the haze arises inside of glass, when it is not on the pixel area, there is no problem in quality.

Before the aluminum bag is opened, please keep the products in the environment below 30°C·90 %RH. And

after the aluminum bag is opened, please keep the products in the environment below 30°C·60 %RH.

Please mount the products within 12 months from sealed date and within 6 months from opening the aluminum bag. (Sealed date is printed on aluminum bag.)

### 4. Ultrasonic Cleaning

Ultrasonic cleaning should not be used with such hermetically-sealed ceramic package as CCD because the bonding wires can become disconnected due to resonance during the cleaning process.

### 5. Mounting

In the case of solder mounting, the devices should be mounted with the window glass protective tape in order to avoid dust or dirt included in reflow machine.

### 6. Window Glass Protective Tape

The window glass protective tape is manufactured from materials in which static charges tend to build up. When removing the tape from CCD sensor after solder mounting, install an ionizer to prevent the tape from being charged with static electricity.

When the tape is removed, adhesives will remain in the glass surface. Since these adhesives appear as black or white flaws on the image, please wipe the window glass surface with the cloth into which the organic solvent was infiltrated. Then please attach CCD to a product.

Do not reuse the tape.



## 7. Soldering Temperature Profile

Good temperature profile for each soldering method is as follows. In addition, in case of the repair work accompanied by IC removal, since the degree of parallel may be spoiled with the left solder, please do not carry out and in case of the repair work not accompanied by IC removal, carry out with a soldering iron or , in reflow, only one time.

- a. Using a soldering iron  
Complete soldering within three seconds for lead temperatures of up to 350°C.
- b. Using long infrared rays reflow / hot air reflow  
Please do reflow at the condition that the package surface (electrode) temperature is on the solder maker's recommendation profile. And that reflow profile is within below condition 1 to 3.
  1. Peak temperature: 250°C or less.
  2. Time to keep high temperature: 220 to 250°C, 30 to 40 s.
  3. Pre. heat: 150 to 190°C, 60 to 120 s

## 8. Window Glass

The dust and stain on the glass window of the package degrade optical performance of CCD sensor. Keep the glass window clean by saturating a cotton swab in alcohol and lightly wiping the surface, and allow the glass to dry, by blowing with filtered dry N<sub>2</sub>. Care should be taken to avoid mechanical or thermal shock because the glass window is easily to damage.

## 9. Cleaning Method of the Window Glass Surface

Wiping Cloth

- a. Use soft cloth with a fine mesh.
- b. The wiping cloth must not cause dust from itself.
- c. Use a clean wiping cloth necessarily.

Cleaner

When using solvents, such as alcohol, unavoidably, it is cautious of the next.

- a. A clean thing with quick-drying.
- b. After liquid dries, there needs to be no residual substance.
- c. A thing safe for a human body.

And, please observe the use term of a solvent and use the storage container of a solvent to be clean. Be cautious of fire enough.

Way of Cleaning

First, the surface of window glass is wiped with the wiping cloth into which the cleaner was infiltrated. Please wipe down the surface of window glass at least 2 times or more.

Next, the surface of window glass wipes with the dry wiping cloth. Please wipe down the surface of window glass at least 3 times or more.

Finally, blow cleaning is performed by dry N<sub>2</sub> filtered.

If operator wipes the surface of the window glass with the above-mentioned process and dirt still remains, TOSHIBA recommends repeating the clean operation from the beginning.

Be cautious of the next thing.

- a. Don't infiltrate the cleaner too much.
- b. A wiping portion is performed into the optical range and don't touch the edge of window glass.
- c. Be sure to wipe in a long direction and the same direction.
- d. A wiping cloth always uses an unused portion.

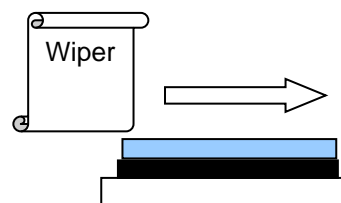

## 10. Foot Pattern on the PCB

We recommend fig.1 's foot pattern for your PCB(Printed Circuit Board).

Unit: mm

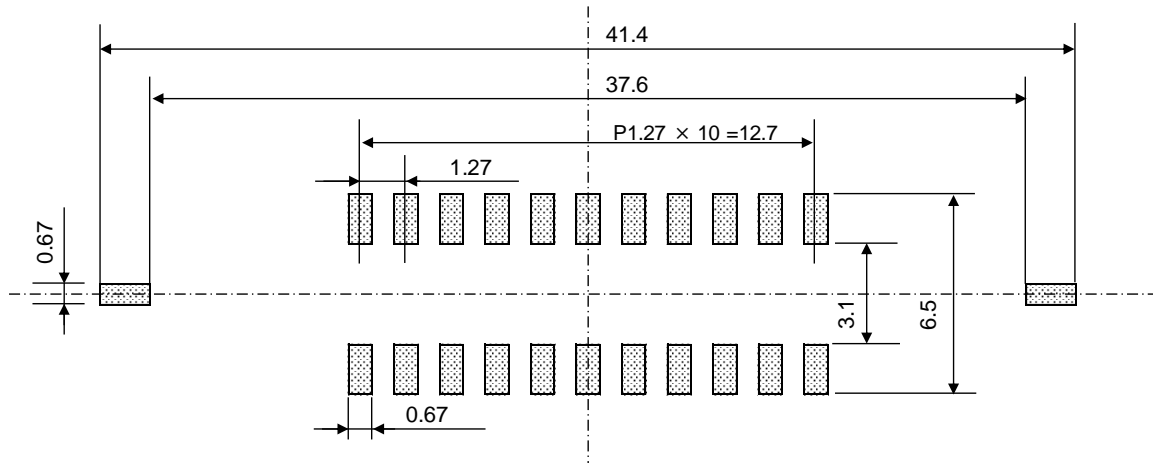

fig. 1

## 11. Mask for Solder Paste Application

We recommend metal mask that have the following thickness.

·Thickness : 0.2 mm.

And we recommend that the opened area size on the metal mask is 95 % to 100 % for pads on solder.

## 12. Temperature Cycle

After mounting, if temperature cycle stress is too much, CCD surface mount products have a possibility that a crack may arise in solder. As a method of preventing a solder crack, underfill is effective.

## 13. Reuse of a Tray

We reuse tray in order to reduce plastic waste as we can. Please cooperate with us in reusing for ecology.

## 14. Caution for Package Handling

Over force on CCD products may cause crack and chip removing on the product. The three point bending strength of this product is the following. (Reference data)

If the stress is loaded far from a fulcrum, the stress on the package will be increase.

When you will treat CCD on every process, please be careful particularly. For example, soldering on PCB, cutting PCB, wiping on the glass surface, optical assemble and so on.

### Bending Test

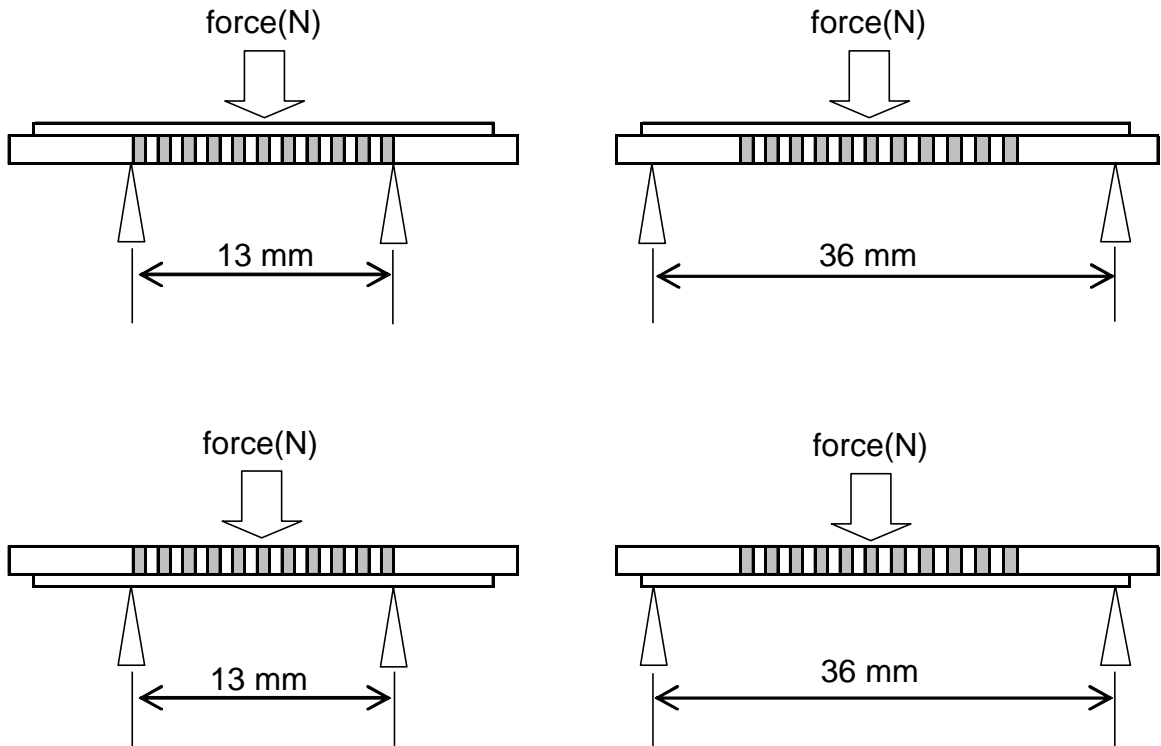

•22CLCC

- Bearing length 13 mm: The force from upside: 300 [N]  
The force from downside: 200 [N]
- Bearing length 36 mm: The force from upside : 150 [N]  
The force from downside : 80 [N]



## RESTRICTIONS ON PRODUCT USE

Toshiba Corporation and its subsidiaries and affiliates are collectively referred to as "TOSHIBA". Hardware, software and systems described in this document are collectively referred to as "Product".

- TOSHIBA reserves the right to make changes to the information in this document and related Product without notice.
- This document and any information herein may not be reproduced without prior written permission from TOSHIBA. Even with TOSHIBA's written permission, reproduction is permissible only if reproduction is without alteration/omission.
- Though TOSHIBA works continually to improve Product's quality and reliability, Product can malfunction or fail. Customers are responsible for complying with safety standards and for providing adequate designs and safeguards for their hardware, software and systems which minimize risk and avoid situations in which a malfunction or failure of Product could cause loss of human life, bodily injury or damage to property, including data loss or corruption. Before customers use the Product, create designs including the Product, or incorporate the Product into their own applications, customers must also refer to and comply with (a) the latest versions of all relevant TOSHIBA information, including without limitation, this document, the specifications, the data sheets and application notes for Product and the precautions and conditions set forth in the "TOSHIBA Semiconductor Reliability Handbook" and (b) the instructions for the application with which the Product will be used with or for. Customers are solely responsible for all aspects of their own product design or applications, including but not limited to (a) determining the appropriateness of the use of this Product in such design or applications; (b) evaluating and determining the applicability of any information contained in this document, or in charts, diagrams, programs, algorithms, sample application circuits, or any other referenced documents; and (c) validating all operating parameters for such designs and applications. **TOSHIBA ASSUMES NO LIABILITY FOR CUSTOMERS' PRODUCT DESIGN OR APPLICATIONS.**
- **PRODUCT IS NEITHER INTENDED NOR WARRANTED FOR USE IN EQUIPMENTS OR SYSTEMS THAT REQUIRE EXTRAORDINARILY HIGH LEVELS OF QUALITY AND/OR RELIABILITY, AND/OR A MALFUNCTION OR FAILURE OF WHICH MAY CAUSE LOSS OF HUMAN LIFE, BODILY INJURY, SERIOUS PROPERTY DAMAGE AND/OR SERIOUS PUBLIC IMPACT ("UNINTENDED USE").** Except for specific applications as expressly stated in this document, Unintended Use includes, without limitation, equipment used in nuclear facilities, equipment used in the aerospace industry, lifesaving and/or life supporting medical equipment, equipment used for automobiles, trains, ships and other transportation, traffic signaling equipment, equipment used to control combustions or explosions, safety devices, elevators and escalators, and devices related to power plant. **IF YOU USE PRODUCT FOR UNINTENDED USE, TOSHIBA ASSUMES NO LIABILITY FOR PRODUCT.** For details, please contact your TOSHIBA sales representative or contact us via our website.
- Do not disassemble, analyze, reverse-engineer, alter, modify, translate or copy Product, whether in whole or in part.
- Product shall not be used for or incorporated into any products or systems whose manufacture, use, or sale is prohibited under any applicable laws or regulations.
- The information contained herein is presented only as guidance for Product use. No responsibility is assumed by TOSHIBA for any infringement of patents or any other intellectual property rights of third parties that may result from the use of Product. No license to any intellectual property right is granted by this document, whether express or implied, by estoppel or otherwise.
- **ABSENT A WRITTEN SIGNED AGREEMENT, EXCEPT AS PROVIDED IN THE RELEVANT TERMS AND CONDITIONS OF SALE FOR PRODUCT, AND TO THE MAXIMUM EXTENT ALLOWABLE BY LAW, TOSHIBA (1) ASSUMES NO LIABILITY WHATSOEVER, INCLUDING WITHOUT LIMITATION, INDIRECT, CONSEQUENTIAL, SPECIAL, OR INCIDENTAL DAMAGES OR LOSS, INCLUDING WITHOUT LIMITATION, LOSS OF PROFITS, LOSS OF OPPORTUNITIES, BUSINESS INTERRUPTION AND LOSS OF DATA, AND (2) DISCLAIMS ANY AND ALL EXPRESS OR IMPLIED WARRANTIES AND CONDITIONS RELATED TO SALE, USE OF PRODUCT, OR INFORMATION, INCLUDING WARRANTIES OR CONDITIONS OF MERCHANTABILITY, FITNESS FOR A PARTICULAR PURPOSE, ACCURACY OF INFORMATION, OR NONINFRINGEMENT.**
- Do not use or otherwise make available Product or related software or technology for any military purposes, including without limitation, for the design, development, use, stockpiling or manufacturing of nuclear, chemical, or biological weapons or missile technology products (mass destruction weapons). Product and related software and technology may be controlled under the applicable export laws and regulations including, without limitation, the Japanese Foreign Exchange and Foreign Trade Law and the U.S. Export Administration Regulations. Export and re-export of Product or related software or technology are strictly prohibited except in compliance with all applicable export laws and regulations.
- Please contact your TOSHIBA sales representative for details as to environmental matters such as the RoHS compatibility of Product. Please use Product in compliance with all applicable laws and regulations that regulate the inclusion or use of controlled substances, including without limitation, the EU RoHS Directive. **TOSHIBA ASSUMES NO LIABILITY FOR DAMAGES OR LOSSES OCCURRING AS A RESULT OF NONCOMPLIANCE WITH APPLICABLE LAWS AND REGULATIONS.**