

HAMAMATSU

FLAT PANEL TYPE MULTIANODE PHOTOMULTIPLIER TUBE ASSEMBLY H9500, H9500-03

52 mm Square, Bialkali Photocathode, 12-stage,
16 × 16 Multianode, Small Dead Space, Fast Time Response

APPLICATIONS

- Small Animal Imaging
- Compact Gamma Camera
- Scinti-mammography
- 2D Radiation Monitor

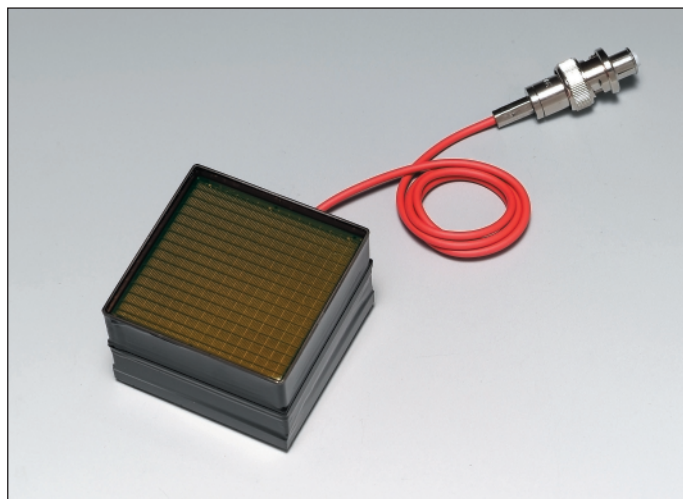

SPECIFICATIONS

GENERAL

Parameter		H9500	H9500-03	Unit
Spectral Response		300 to 650	185 to 650	nm
Peak Wavelength		400		nm
Photocathode Material		Bialkali		—
Window	Material	Borosilicate glass	UV glass	—
	Thickness	1.5		mm
Dynode	Structure	Metal channel dynode		—
	Number of Stages	12		—
Number of Anode Pixels		256 (16 × 16 matrix)		—
Pixel Size / Pitch at Center		2.8 × 2.8 / 3.04		mm
Effective Area		49 × 49		mm
Dimensional Outline (W × H × D)		52 × 52 × 33.3		mm
Packing Density (Effective Area / External Size)		89		%
Weight		177		g
Operating Ambient Temperature		0 to +50		°C
Storage Temperature		-15 to +50		°C

MAXIMUM RATINGS (Absolute Maximum Values)

Parameter	H9500	H9500-03	Unit
Supply Voltage (Between Anode to Cathode)	-1100		V
Average Anode Output Current in Total	100		μA
Divider Current at -1100 V	180		μA

Subject to local technical requirements and regulations, availability of products included in this promotional material may vary. Please consult with our sales office.
Information furnished by HAMAMATSU is believed to be reliable. However, no responsibility is assumed for possible inaccuracies or omissions. Specifications are subject to change without notice. No patent rights are granted to any of the circuits described herein. ©2007 Hamamatsu Photonics K.K.

FLAT PANEL TYPE MULTIANODE PHOTOMULTIPLIER TUBE ASSEMBLY H9500, H9500-03

CHARACTERISTICS (at 25 °C)

Parameter		Min.	Typ.	Max.	Unit
Cathode Sensitivity	Luminous [Ⓐ]	50	60	—	μA/lm
	Blue Sensitivity Index (CS 5-58) [Ⓑ]	8.0	9.5	—	—
Quantum Efficiency at 420 nm		—	24	—	%
Anode Sensitivity	Luminous [Ⓒ]	—	90	—	A/lm
Gain [Ⓒ]		0.5×10^6	1.5×10^6	—	—
Anode Dark Current per Channel [Ⓓ]		—	0.05	—	nA
Anode Dark Current in Total [Ⓓ]		—	13	50	nA
Time Response [Ⓔ]	Rise Time [Ⓕ]	—	0.8	—	ns
	Transit Time [Ⓖ]	—	6	—	ns
	Transit Time Spread (FWHM) [Ⓗ]	—	0.4	—	ns
Pulse Linearity per Channel (±2 % deviation)		—	0.2	—	mA
Anode Uniformity (Condition Figure 3)		—	1:4	1:6	—
Cross-talk [Ⓙ]		—	5	—	%

NOTES

- Ⓐ: The light source is a tungsten filament lamp operated at a distribution temperature of 2856 K. Supply voltage is 150 volts between the cathode and all other electrodes connected together as anode.
- Ⓑ: The value is cathode output current when a blue filter (corning CS 5-58 polished to 1/2 stock thickness) is interposed between the light source and the tube under the same condition as Note Ⓐ.
- Ⓒ: Measured with the same light source as Note Ⓐ and with the anode-to-cathode supply voltage and voltage distribution ratio shown in Table 1 below.
- Ⓓ: Measured with the same supply voltage and voltage distribution ratio as Note Ⓒ after 30 minutes storage in darkness.
- Ⓔ: Those are test data when a signal from a central channel of 256 anodes is used, while all photocathode are illuminated by pulsed light source.
- Ⓕ: The rise time is the time for the output pulse to rise from 10 % to 90 % of the peak amplitude when the whole photocathode is illuminated by a delta function light pulse.
- Ⓖ: The electron transit time is the interval between the arrival of delta function light pulse at the entrance window of the tube and the time when the anode output reaches the peak amplitude. In measurement, the whole photocathode is illuminated.
- Ⓗ: Also called transit time jitter. This is the fluctuation in electron transit time between individual pulses in the single photoelectron event, and defined as the FWHM of the frequency distribution of electron transit time.
- Ⓙ: Supply Voltage: -1000 V Light Source: Tungsten filament lamp + blue filter (corning CS 5-58 polished to 1/2 stock thickness)
Aperture Size: Approx. 2 mm × 2 mm
One anode is illuminated through the aperture and the output of the adjacent anodes are calculated as relative value, with 100 % being equal to the output of the illuminated anode. The cross-talk is the relative value of the adjacent anodes expressed in %.

Table 1: Voltage Distribution Ratio and Supply Voltage

Electrodes	K	Dy1	Dy2	Dy3	Dy4	Dy5	Dy6	Dy7	Dy8	Dy9	Dy10	Dy11	Dy12	GR	P
Distribution Ratio	1	1	1	1	1	1	1	1	1	1	1	1	1	0.9	0.1

Supply Voltage: -1000 V, K: Cathode, Dy: Dynode, GR: Guard Ring P: Anode

Figure 1: Typical Spectral Response

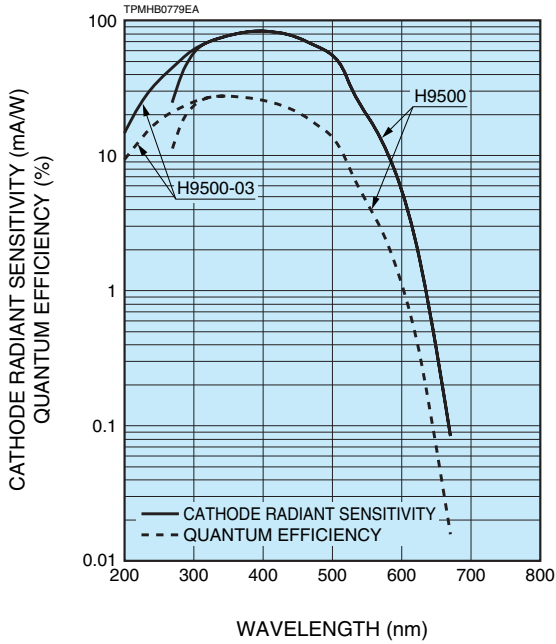

Figure 2: Typical Gain Characteristics

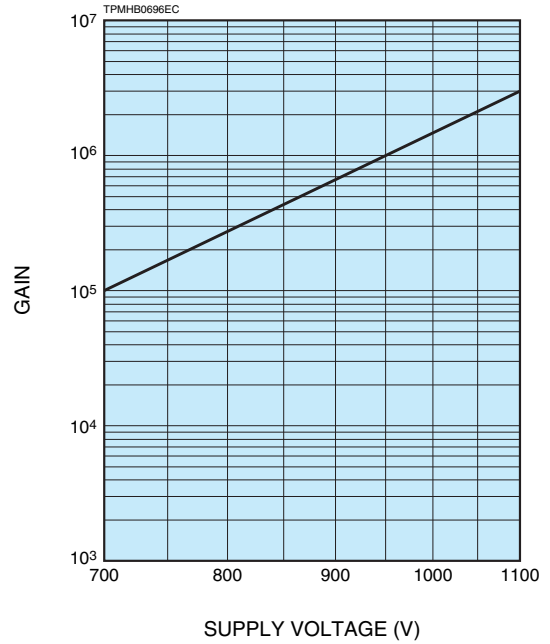

Figure 3: Anode Uniformity (Example)

P1	78	78	86	79	83	92	92	93	90	91	93	88	87	77	84	P16	
	79	77	77	74	81	87	91	91	87	85	80	80	69	69	74	83	
	72	43	74	77	86	91	96	99	100	97	90	76	54	59	80	85	
	63	61	66	67	71	77	80	89	94	90	84	74	51	51	79	87	
	52	52	57	58	63	69	74	80	83	84	84	77	63	59	78	88	
	50	48	52	53	61	66	67	76	78	78	79	83	71	68	79	89	
	46	44	48	49	57	57	61	69	74	71	74	84	73	73	82	90	
	43	41	44	46	54	55	59	66	71	72	75	84	78	72	79	93	
	42	38	43	45	51	54	57	62	69	70	76	86	77	71	77	92	
	39	39	43	44	50	53	55	63	71	71	73	85	71	67	77	94	
	39	39	42	44	51	56	55	65	73	71	75	83	68	58	77	94	
	39	39	42	42	49	57	64	70	78	79	79	79	64	53	75	91	
	38	39	44	44	50	56	64	71	82	81	81	79	64	55	74	84	
	38	42	48	52	58	63	72	79	83	80	79	80	71	69	72	79	
	35	38	48	51	54	56	61	62	71	69	68	71	63	59	55	66	
	29	40	53	52	55	57	58	55	65	60	59	65	61	61	52	48	P256

TOP VIEW

SUPPLY VOLTAGE: -1000 V
LIGHT SOURCE: TUNGSTEN LAMP with BLUE FILTER (DC LIGHT)
SPOT ILLUMINATION (APERTURE SIZE): 3 mm square on each channel

TPMHB0730EB

Figure 4: Anode Matrix and Separation Mark

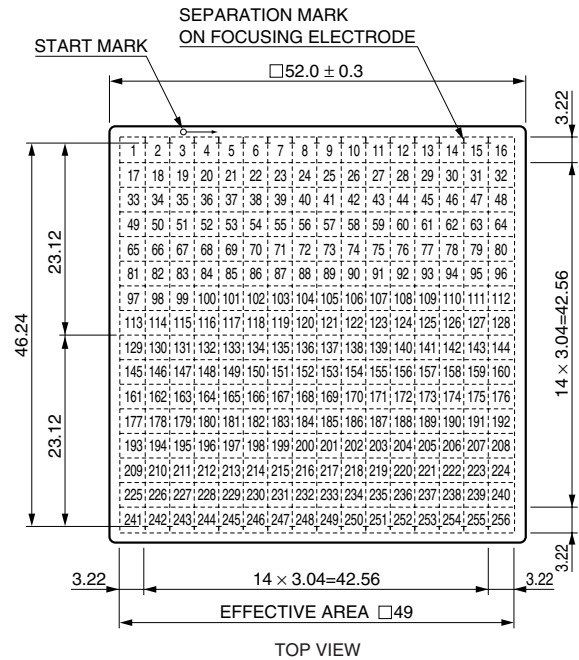

The start mark and the separation marks are put on an electrode plate inside.

TPMHB0731EA

FLAT PANEL TYPE MULTIANODE PHOTOMULTIPLIER TUBE ASSEMBLY H9500, H9500-03

Figure 5: Dimensional Outline (Unit: mm)

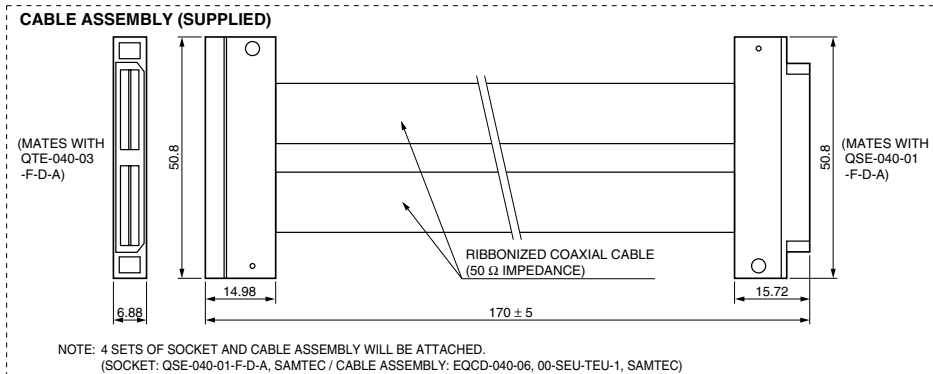
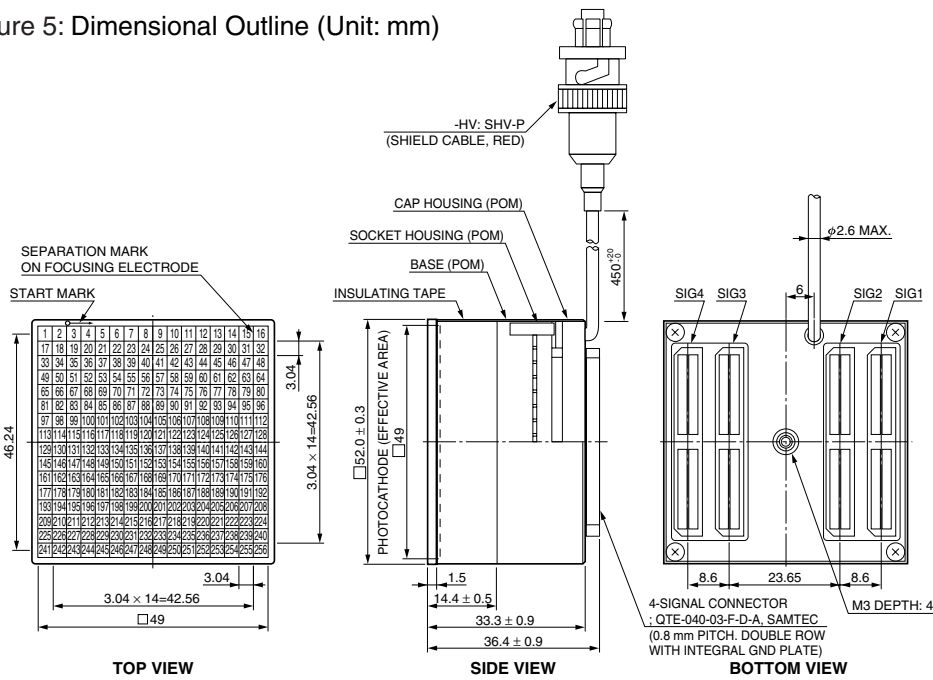

CONNECTION FOR SIGNAL CONNECTORS (BOTTOM VIEW)

SIG4		SIG3		SIG2		SIG1	
GND	GND	GND	GND	GND	GND	GND	GND
GND	GND	GND	GND	GND	GND	GND	GND
GND	GND	GND	GND	GND	GND	GND	GND
GND	GND	GND	GND	GND	GND	GND	GND
P15	P13	P11	P9	P7	P5	P3	P1
P16	P14	P12	P10	P8	P6	P4	P2
P31	P29	P27	P25	P23	P21	P19	P17
P32	P30	P28	P26	P24	P22	P20	P18
P47	P45	P43	P41	P39	P37	P35	P33
P48	P46	P44	P42	P40	P38	P36	P34
P63	P61	P59	P57	P55	P53	P51	P49
P64	P62	P60	P58	P56	P54	P52	P50
P79	P77	P75	P73	P71	P69	P67	P65
P80	P78	P76	P74	P72	P70	P68	P66
P95	P93	P91	P89	P87	P85	P83	P81
P96	P94	P92	P90	P88	P86	P84	P82
P111	P109	P107	P105	P103	P101	P99	P97
P112	P110	P108	P106	P104	P102	P100	P98
P127	P125	P123	P121	P119	P117	P115	P113
P128	P126	P124	P122	P120	P118	P116	P114
P143	P141	P139	P137	P135	P133	P131	P129
P144	P142	P140	P138	P136	P134	P132	P130
P159	P157	P155	P153	P151	P149	P147	P145
P160	P158	P156	P154	P152	P150	P148	P146
P175	P173	P171	P169	P167	P165	P163	P161
P176	P174	P172	P170	P168	P166	P164	P162
P191	P189	P187	P185	P183	P181	P179	P177
P192	P190	P188	P186	P184	P182	P180	P178
P207	P205	P203	P201	P199	P197	P195	P193
P208	P206	P204	P202	P200	P198	P196	P194
P223	P221	P219	P217	P215	P213	P211	P209
P224	P222	P220	P218	P216	P214	P212	P210
P239	P237	P235	P233	P231	P229	P227	P225
P240	P238	P236	P234	P232	P230	P228	P226
P255	P253	P251	P249	P247	P245	P243	P241
P256	P254	P252	P250	P248	P246	P244	P242
GND	GND	GND	GND	GND	GND	GND	GND
GND	GND	GND	GND	GND	GND	GND	GND
GND	GND	GND	GND	GND	GND	GND	GND
GND	GND	GND	GND	GND	GND	GND	GND
DY12 OUTPUT							

METAL PLATE (GND)

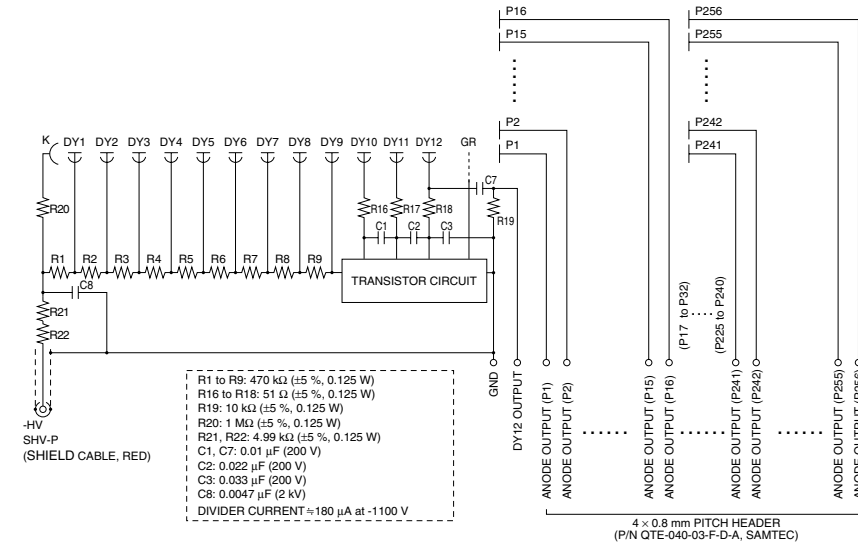

HAMAMATSU

WEB SITE www.hamamatsu.com

HAMAMATSU PHOTONICS K.K., Electron Tube Division

314-5, Shimokanzo, Iwata City, Shizuoka Pref., 438-0193, Japan, Telephone: (81)539/62-5248, Fax: (81)539/62-2205

U.S.A.: Hamamatsu Corporation: 360 Foothill Road, P. O. Box 6910, Bridgewater, N.J. 08807-0910, U.S.A., Telephone: (1)908-231-0960, Fax: (1)908-231-1218 E-mail: usa@hamamatsu.com

Germany: Hamamatsu Photonics Deutschland GmbH: Arzbergerstr. 10, D-82211 Herrsching am Ammersee, Germany, Telephone: (49)8152-375-0, Fax: (49)8152-2658 E-mail: info@hamamatsu.de

France: Hamamatsu Photonics France S.A.R.L.: 19, Rue du Saule Trapu, Parc du Moulin de Massy, 91882 Massy Cedex, France, Telephone: (33)1 69 53 71 00, Fax: (33)1 69 53 71 10 E-mail: infos@hamamatsu.fr

United Kingdom: Hamamatsu Photonics UK Limited: 2 Howard Court, 10 Tewin Road Welwyn Garden City Hertfordshire AL7 1BW, United Kingdom, Telephone: 44-(0)1707-294888, Fax: 44(0)1707-325777 E-mail: info@hamamatsu.co.uk

North Europe: Hamamatsu Photonics Norden AB: Smidesvägen 12, SE-171-41 SOLNA, Sweden, Telephone: (46)8-509-031-00, Fax: (46)8-509-031-01 E-mail: info@hamamatsu.se

Italy: Hamamatsu Photonics Italia: S.R.L.: Strada della Moia, 1/E, 20020 Arese, (Milano), Italy, Telephone: (39)02-935 81 733, Fax: (39)02-935 81 741 E-mail: info@hamamatsu.it

TPMH1309E1C

TPMH1309E1
OCT. 2007 IP