

**Photomultiplier Tube with Active Divider Circuit  
Linear Array Multianode PMT Assembly, 8-channel(H9530 series) /  
16-channel(H10515B series) / 32-channel(H7260 series)**

**FEATURES**

- **High Cathode Sensitivity**  
Luminous 500  $\mu\text{A/lm}$  Typ. (-20 Type)
- **Effective Area per Channel**  
H9530 / H11451 / H11452 Series ... 2.0 mm  $\times$  2.5 mm  $\times$  8 Anodes  
H10515B / H11459 Series ... 0.8 mm  $\times$  16 mm  $\times$  16 Anodes  
H7260 / H11460 Series ..... 0.8 mm  $\times$  7 mm  $\times$  32 Anodes
- **High Speed Response:**  
H9530 Series Rise Time ..... 0.7 ns Typ.  
H10515B Series, H7260 Series Rise Time ... 0.6 ns Typ.
- **Good Anode Uniformity (H9530 Series)**  
1:1.1 Max. (at -1000 V and peak wavelength)
- **Low Cross-talk (H9530 Series)**  
0.1 % Typ. (each channel)  
Black slit faceplate used
- **Built In Preamplifier and High Voltage Power Supply Circuit (Module Types)**

**APPLICATIONS**

- **Biomedical Fluorescence Detection**
- **Laser Scanning Detection**
- **Spectroscopy**
- **Environmental Monitoring**

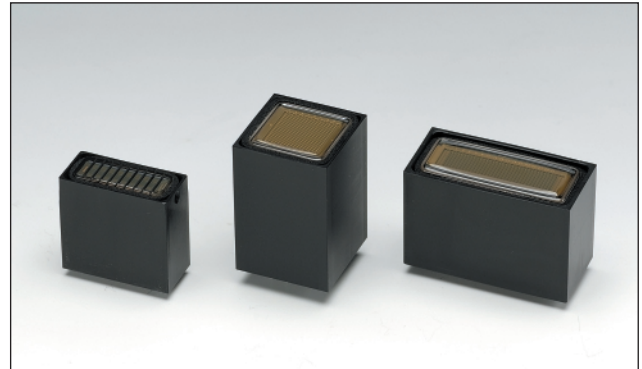

Assembly Types: H9530 Series, H10515B Series, H7260 Series

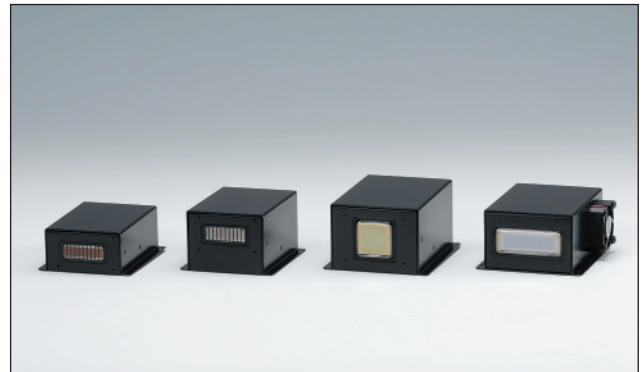

Module Types: H11451, H11452, H11459, H11460

Figure 1: Typical Spectral Response

-03 and None Suffix Types

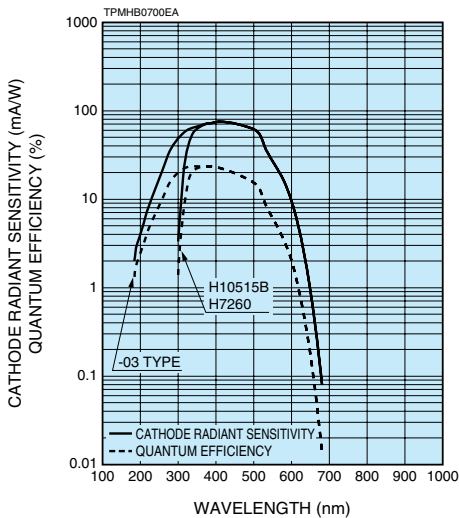

-100 and -200 Types

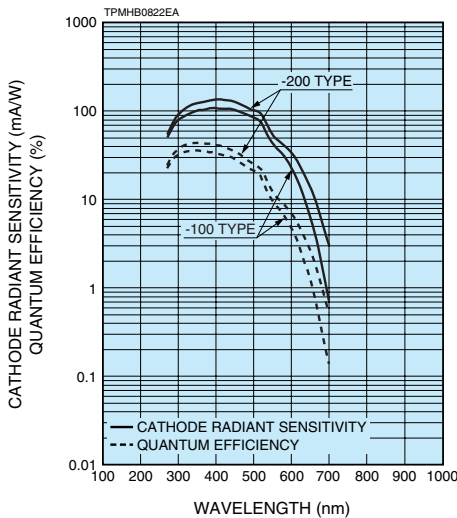

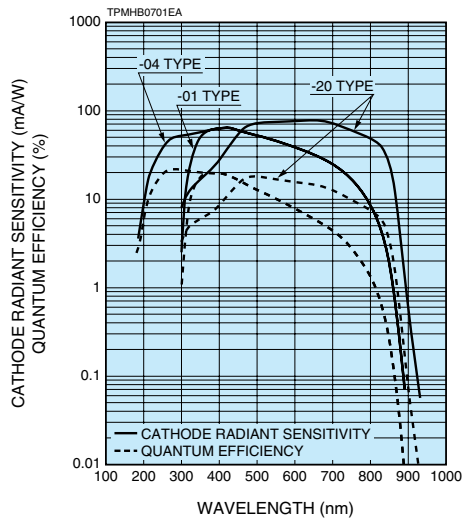

-01, -04 and -20 Types

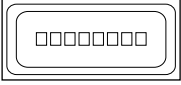
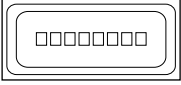

# LINEAR ARRAY MULTIANODE PMT ASSEMBLIES AND MODULES

## SPECIFICATIONS OF ASSEMBLY TYPES

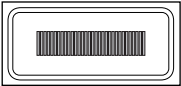
Type No.	Anode Type		Dimensional Outline	Effective Area per Channel	Channel Pitch	Dynode Structure / No. of Stages <sup>(A)</sup>	Weight (g)	Insulation Cover Material <sup>(B)</sup>
				(mm)	(mm)			
H9530 SERIES	8-channel Linear Array		See Fig.6	2.0 × 2.5	2.8	MC/12	25.5	P.O.M.
H10515B SERIES	16-channel Linear Array		See Fig.7	0.8 × 16	1	MC/10	49.0	P.O.M.
H7260 SERIES	32-channel Linear Array		See Fig.8	0.8 × 7	1	MC/10	62.0	P.O.M.

Notes: <sup>(A)</sup> MC: Metal Channel

<sup>(B)</sup> P.O.M.: Polyoxymethylene

\* Operating ambient temperature: 0 °C to +50 °C (No condensation)

Storage temperature: -15 °C to +50 °C (No condensation)

Type No.	Spectral Response		Photocathode Material <sup>(F)</sup>	Window Material <sup>(G)</sup>	Cathode Characteristics				Supply Voltage (V dc)	
	Range (nm)	Peak Wavelength (nm)			Luminous		Blue Sensitivity Index (CS 5-58) Typ.	Red /White Ratio (R-68) Typ.		Radiant <sup>(H)</sup> Typ. (mA/W)
					Min. (μA/lm)	Typ. (μA/lm)				
H9530-01	300 to 880	420	MA	B	150	250	—	0.3	65	-1000
H9530-20	300 to 920	630	MA	B	350	500	—	0.45	78	-1000
H10515B	300 to 650	420	BA	B	50	70	8.5	—	72	-800
H10515B-01	300 to 880	420	MA	B	150	250	—	0.3	65	-800
H10515B-03	185 to 650	420	BA	U	50	70	8.5	—	72	-800
H10515B-04	185 to 880	420	MA	U	150	250	—	0.3	65	-800
H10515B-20	300 to 920	630	MA	B	350	500	—	0.45	78	-800
H10515B-100	300 to 650	400	SBA	B	90	105	13.5	—	110	-800
H10515B-200	300 to 650	400	UBA	B	110	135	15.5	—	130	-800
H7260	300 to 650	420	BA	B	50	70	8.5	—	72	-800
H7260-01	300 to 880	420	MA	B	150	250	—	0.3	65	-800
H7260-03	185 to 650	420	BA	U	50	70	8.5	—	72	-800
H7260-04	185 to 880	420	MA	U	150	250	—	0.3	65	-800
H7260-20	300 to 920	630	MA	B	350	500	—	0.45	78	-800
H7260-100	300 to 650	400	SBA	B	90	105	13.5	—	110	-800
H7260-200	300 to 650	400	UBA	B	110	135	15.5	—	130	-800

Notes: <sup>(F)</sup> BA: Bialkali MA: Multialkali SBA: Super Bialkali UBA: Ultra Bialkali

<sup>(G)</sup> B: Borosilicate glass U: UV glass

<sup>(H)</sup> Measured at the peak wavelength

(at 25 °C)

Socket	Maximum Ratings				Type No.
	Maximum Supply Voltage (V dc)	Total Average Anode Current (μA)	Average Anode Current per Channel (μA)	Voltage Divider Current (mA)	
SD-106-T-22	-1200	80	10	0.42	H9530 SERIES
SD-108-T-22 ASP24307-02	-900	100	10	0.37	H10515B SERIES
SD-108-T-22 × 2 pcs	-900	100	6	0.37	H7260 SERIES

Notes: © Supplied  
 ④ Averaged over any interval of 30 seconds maximum.  
 ⑤ Measured with the maximum supply voltage.

(at 25 °C)

Anode Characteristics ①							Pulse Linearity per Channel (±2 % deviation) (mA)	Cross-talk Typ. (%)	Uniformity Between Each Anode		Type No.	
Luminous		Gain Typ.	Dark Current per Channel (After 30 min.)		Time Response				Typ. (%)	Typ.		Max.
Min. (A/lm)	Typ. (A/lm)		Typ. (nA)	Max. (nA)	Rise Time Typ. (ns)	Transit Time Spread (FWHM) Typ. (ns)						
75	750	3 × 10 <sup>6</sup>	0.5	5	0.7	0.25	0.9	0.1	—	1: 1.1 ②	H9530-01	
175	1500	3 × 10 <sup>6</sup>	1	10	0.7	0.25	0.9	0.1	—	1: 1.1 ②	H9530-20	
50	280	4 × 10 <sup>6</sup>	0.2	2	0.6	0.18	0.8	3	1: 1.5	1: 2	H10515B	
75	250	1 × 10 <sup>6</sup>	0.5	5	0.6	0.18	0.8	3	1: 1.7	1: 2.5	H10515B-01	
50	280	4 × 10 <sup>6</sup>	0.2	2	0.6	0.18	0.8	3	1: 1.5	1: 2	H10515B-03	
75	250	1 × 10 <sup>6</sup>	0.5	5	0.6	0.18	0.8	3	1: 1.7	1: 2.5	H10515B-04	
175	500	1 × 10 <sup>6</sup>	1	10	0.6	0.18	0.8	3	1: 1.7	1: 2.5	H10515B-20	
90	315	3 × 10 <sup>6</sup>	0.2	2	0.6	0.18	0.8	3	1: 1.5	1: 2	H10515B-100	
110	405	3 × 10 <sup>6</sup>	0.2	2	0.6	0.18	0.8	3	1: 1.5	1: 2	H10515B-200	
50	140	2 × 10 <sup>6</sup>	0.2	2	0.6	0.18	0.6	3	1: 1.5	1: 2	H7260	
75	250	1 × 10 <sup>6</sup>	0.5	5	0.6	0.18	0.6	3	1: 1.7	1: 2.5	H7260-01	
50	140	2 × 10 <sup>6</sup>	0.2	2	0.6	0.18	0.6	3	1: 1.5	1: 2	H7260-03	
75	250	1 × 10 <sup>6</sup>	0.5	5	0.6	0.18	0.6	3	1: 1.7	1: 2.5	H7260-04	
175	500	1 × 10 <sup>6</sup>	1	10	0.6	0.18	0.6	3	1: 1.7	1: 2.5	H7260-20	
90	210	2 × 10 <sup>6</sup>	0.2	2	0.6	0.18	0.6	3	1: 1.5	1: 2	H7260-100	
110	270	2 × 10 <sup>6</sup>	0.2	2	0.6	0.18	0.6	3	1: 1.5	1: 2	H7260-200	

Notes: ① Anode characteristics are measured with the supply voltage.  
 ② Uniformity is adjusted at HAMAMATSU

# LINEAR ARRAY MULTIANODE PMT ASSEMBLIES AND MODULES

Figure 2: Typical Gain Characteristics

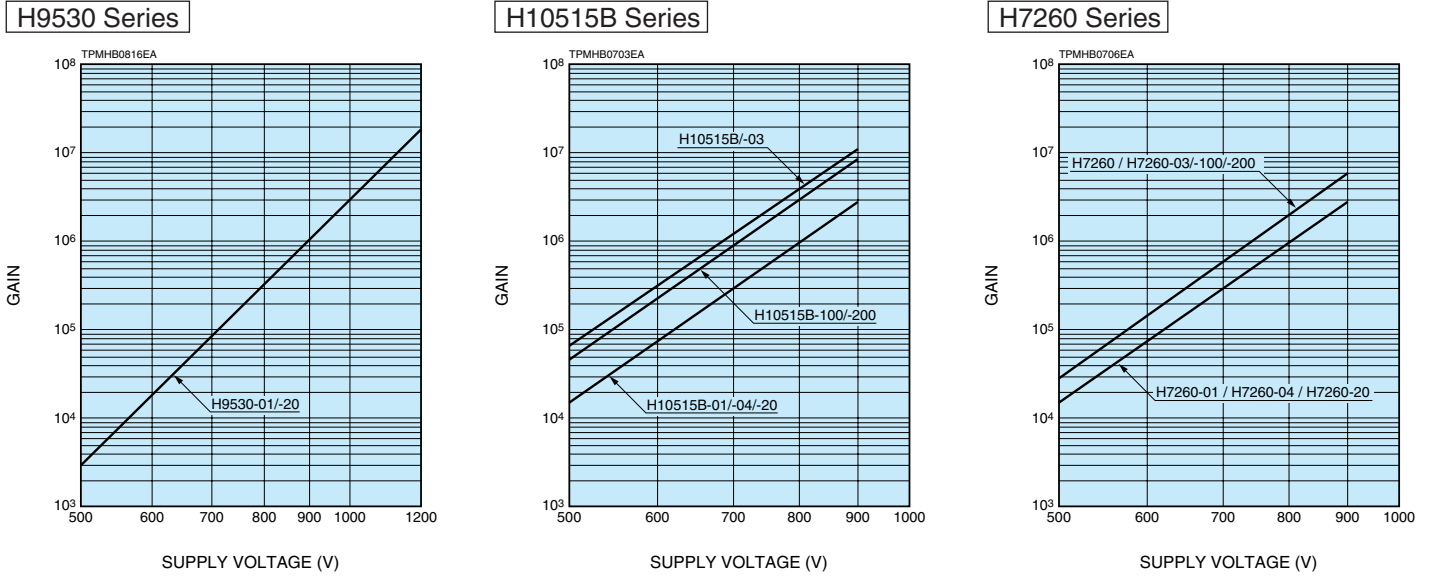
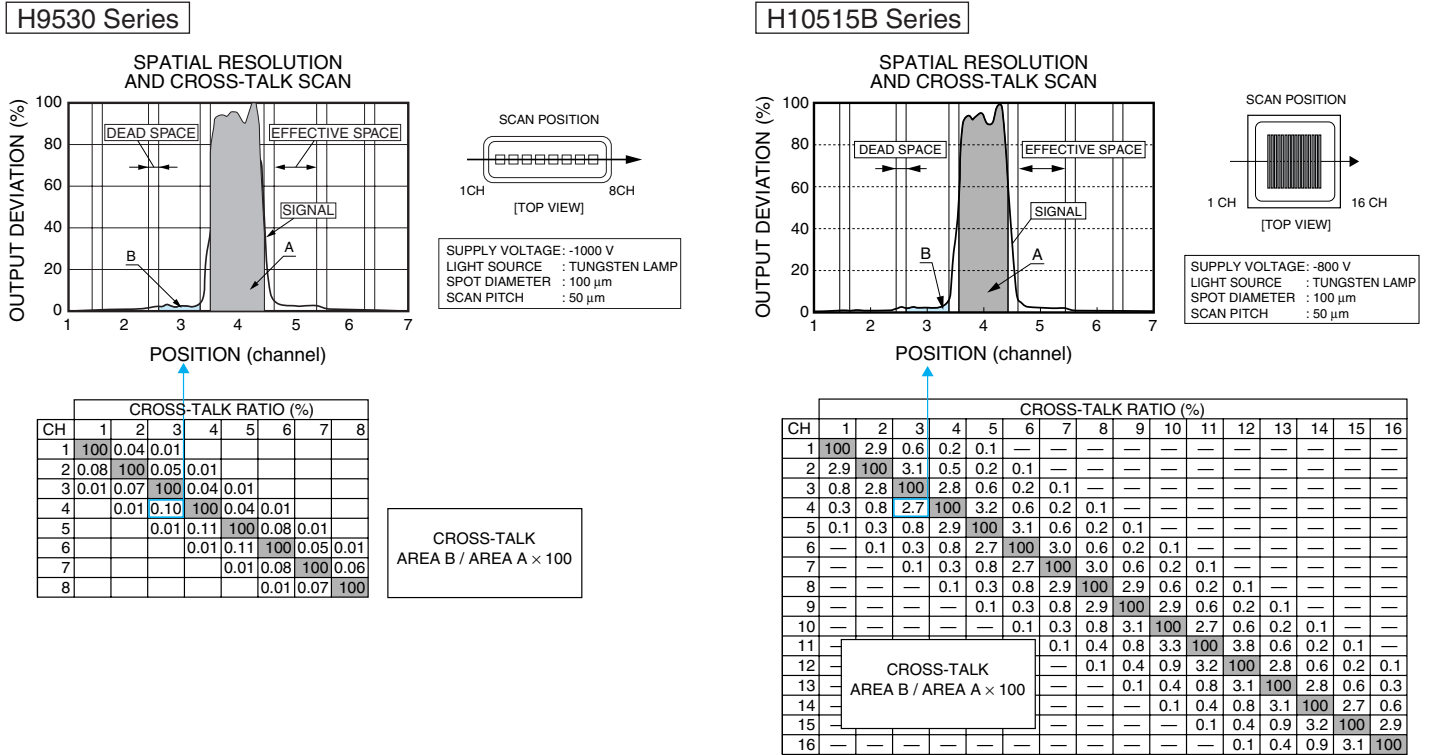

Figure 3: Cross-Talk (Example)



TPMHB0817EA

TPMHB0705EA

\* H7260 series is equivalent to H10515B series.

Figure 4: Typical Time Response

**H9530 Series**

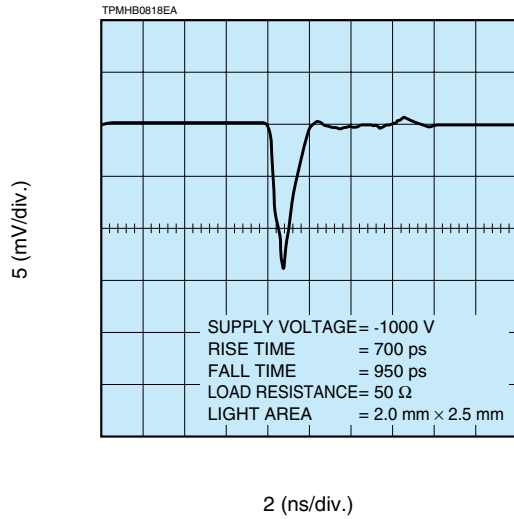

Light is irradiated to only one channel at this measurement.

**H10515B Series**

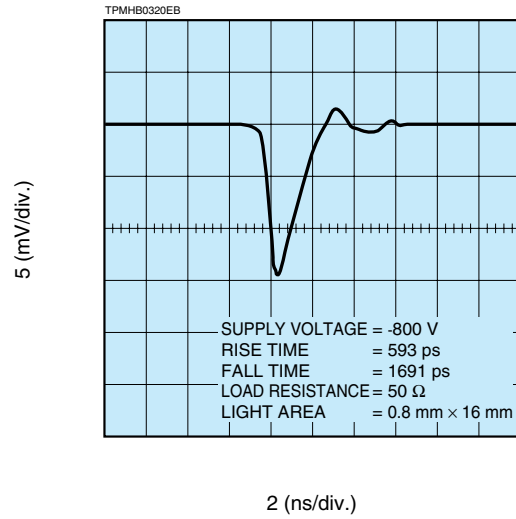

Light is irradiated to only one channel at this measurement.

\* H7260 series is equivalent to H10515B series.

Figure 5: Typical Transit Time Spread Characteristics

**H9530 Series**

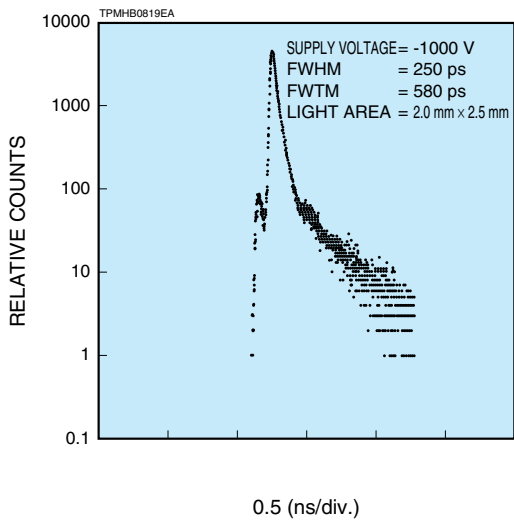

Light is irradiated to only one channel at this measurement.

**H10515B Series**

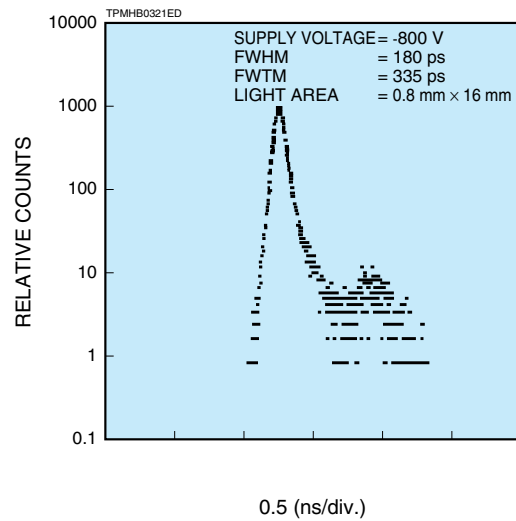

Light is irradiated to only one channel at this measurement.

\* H7260 series is equivalent to H10515B series.

# LINEAR ARRAY MULTIANODE PMT ASSEMBLIES AND MODULES

Figure 6: Dimensional Outline (Unit: mm)

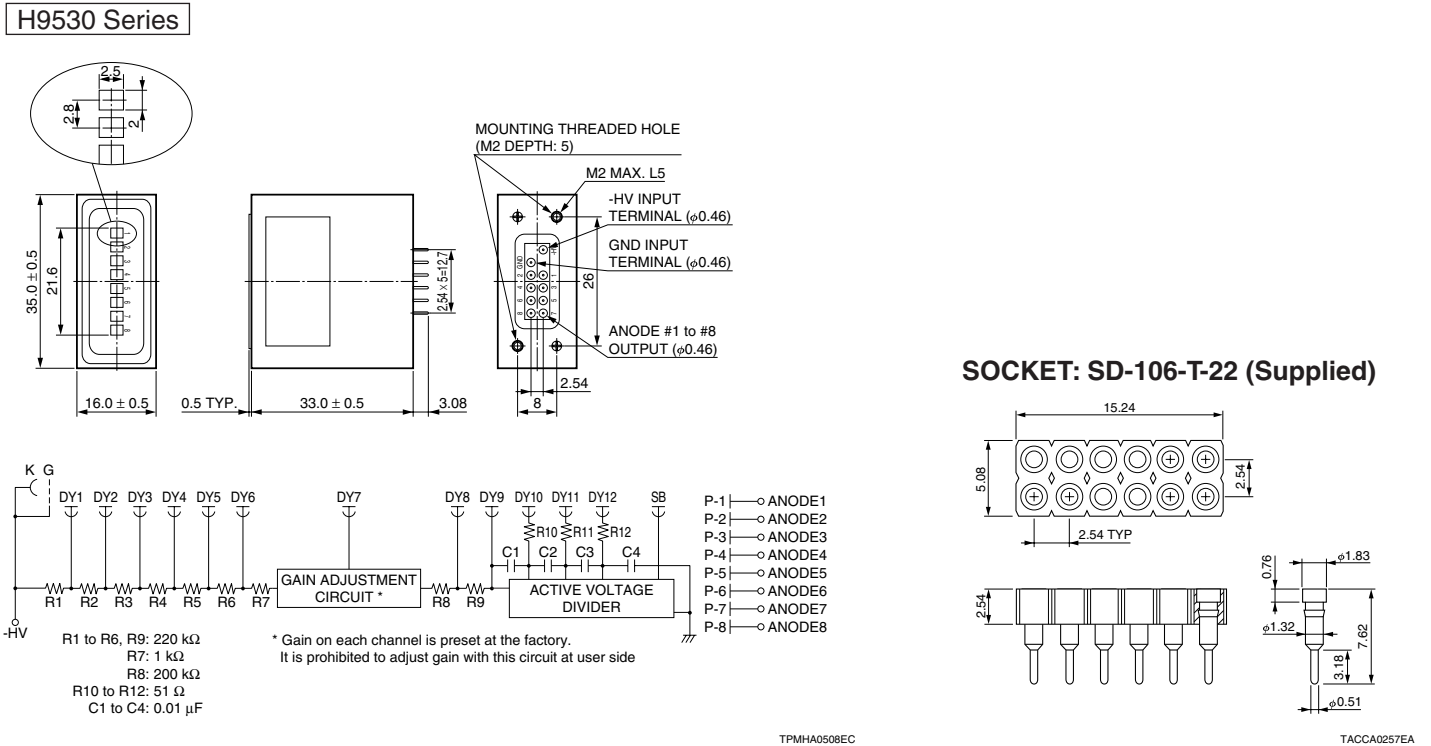

Figure 7: Dimensional Outline (Unit: mm)

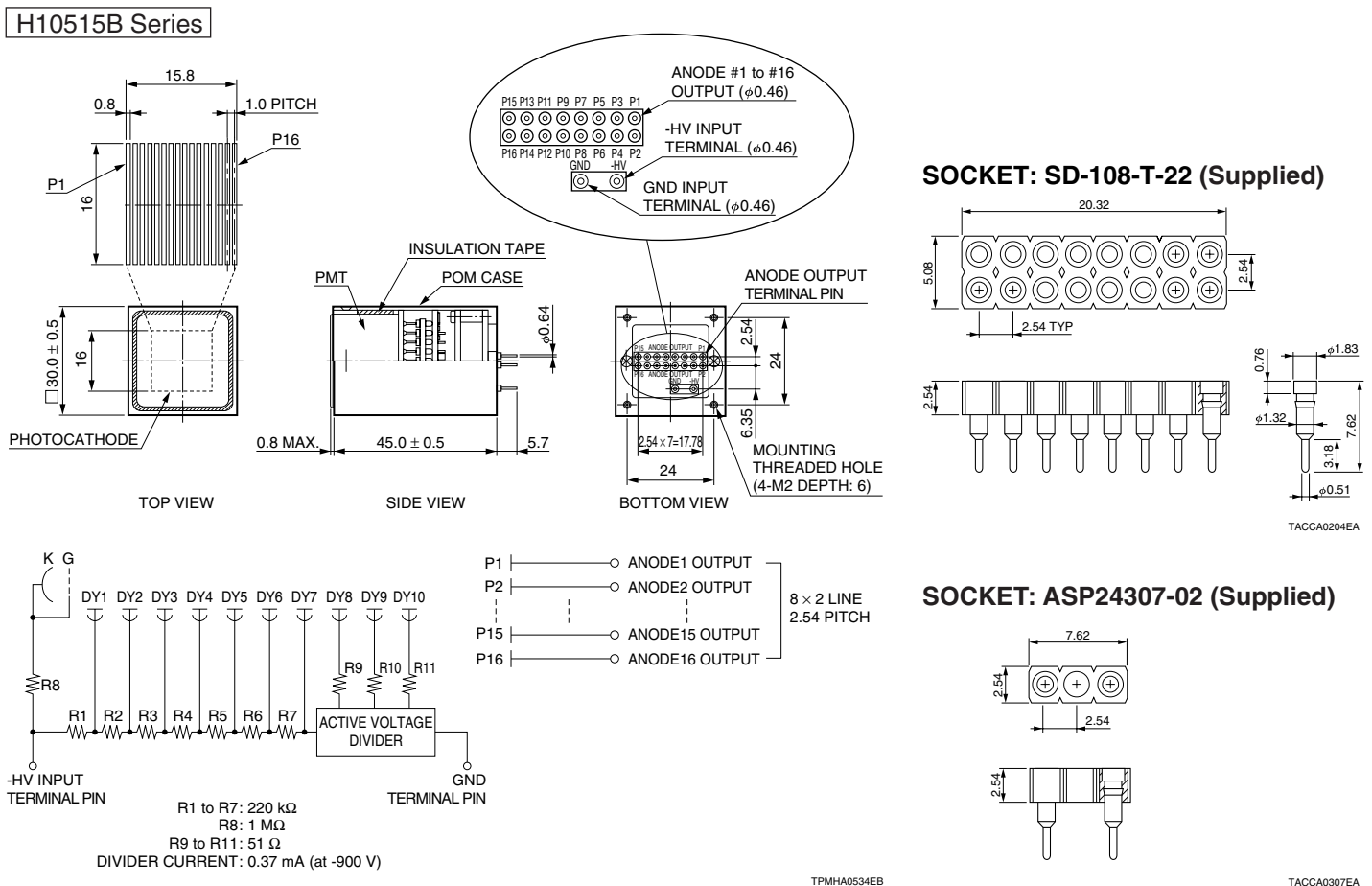
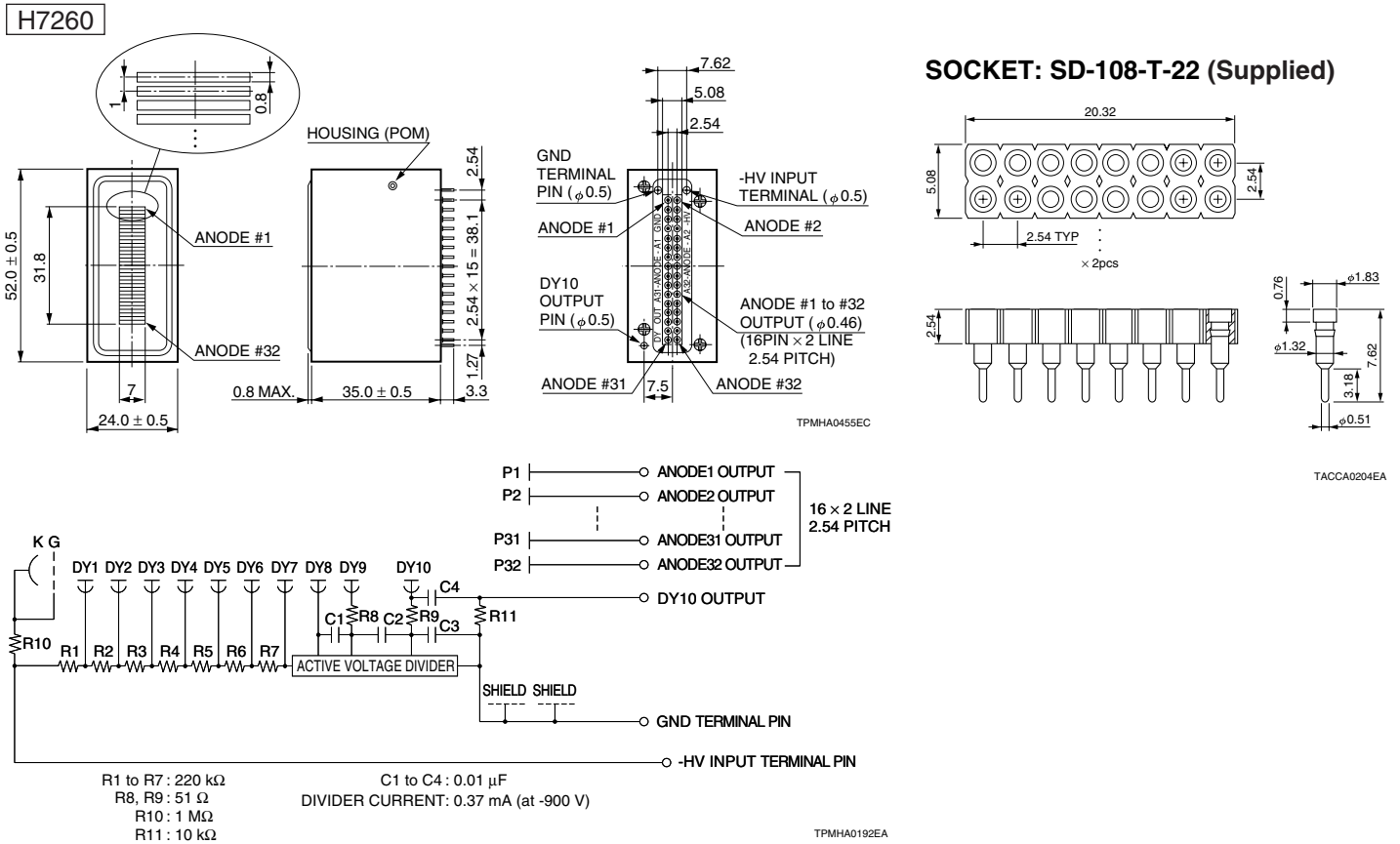
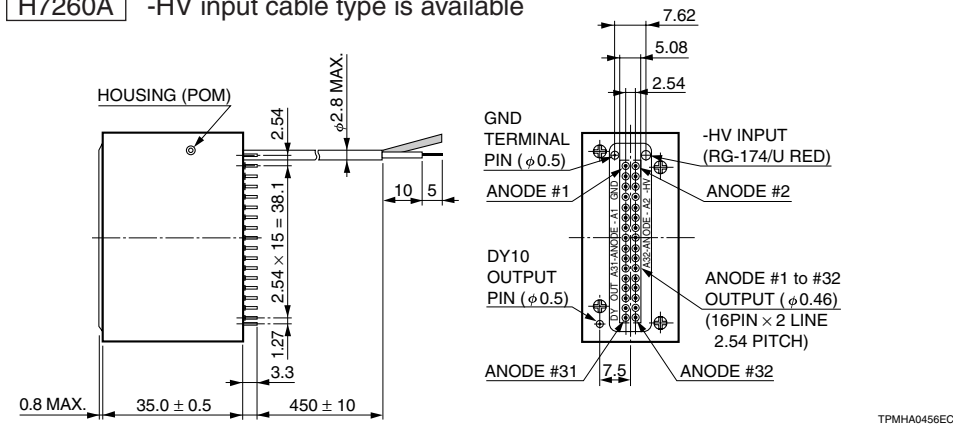

Figure 8: Dimensional Outline and Circuit Diagram (Unit: mm)



**H7260A** -HV input cable type is available



**RELATED PRODUCTS for H9530 / H10515B / H7260 SERIES**



C4900, C4900-01



C10673, C10673-01

**HIGH VOLTAGE POWER SUPPLY UNIT**

Type No.	Max. Output Voltage (V)	Output Current (mA)	Input Voltage (mA)	Dimensions (mm)	Weight (g)
C4900	-1250	0.6	+15	46 × 24 × 12	31
C4900-01		0.5	+12		
C10673		0.6	+15		
C10673-01		0.5	+12		

\* C10673, C10673-01: UL recognized

# LINEAR ARRAY MULTIANODE PMT ASSEMBLIES AND MODULES

## SPECIFICATIONS OF MODULE TYPES

Type No.	Anode Type		Dimensional Outline	Effective Area per Channel (mm)	Channel Pitch (mm)	Maximum Ratings			
						Input Voltage (V)	Control Voltage (V)	Output Signal Voltage	
								DC Output per Channel (V)	Pulse Output per Channel (V)
H11451 SERIES	8-channel Linear Array		See Fig.10	2.0 × 2.5	2.8	±16	+4.8	+1	+10
H11452 SERIES	8-channel Linear Array		See Fig.11	2.0 × 2.5	2.8	±16	+4.8	+1	+10
H11459 SERIES	16-channel Linear Array		See Fig.12	0.8 × 16	1	±16	+3.6	+1	+10
H11460 SERIES	32-channel Linear Array		See Fig.13	0.8 × 7	1	±16	+3.6	+0.6	+6

Notes: (A) Input impedance = 400 kΩ

(B) Load resistance = 10 kΩ

(C) Pulse width = 10 μs, Duty ratio = 1/100

\* Operating ambient temperature: +5 °C to +45 °C

Storage temperature: -20 °C to +50 °C

Type No.	Spectral Response		Photocathode Material <sup>(E)</sup>	Window Material <sup>(F)</sup>	Cathode Characteristics				
	Range (nm)	Peak Wavelength (nm)			Luminous		Blue Sensitivity Index (CS 5-58) Typ.	Red /White Ratio (R-68) Typ.	Radiant <sup>(G)</sup> Typ. (mA/W)
					Min. (μA/lm)	Typ. (μA/lm)			
H11451-01	300 to 880	420	MA	B	150	250	—	0.3	65
H11451-20	300 to 920	630	MA	B	350	500	—	0.45	78
H11452-01	300 to 880	420	MA	B	150	250	—	0.3	65
H11452-20	300 to 920	630	MA	B	350	500	—	0.45	78
H11459	300 to 650	420	BA	B	50	70	8.5	—	72
H11459-01	300 to 880	420	MA	B	150	250	—	0.3	65
H11459-03	185 to 650	420	BA	U	50	70	8.5	—	72
H11459-04	185 to 880	420	MA	U	150	250	—	0.3	65
H11459-20	300 to 920	630	MA	B	350	500	—	0.45	78
H11459-100	300 to 650	400	SBA	B	90	105	13.5	—	110
H11459-200	300 to 650	400	UBA	B	110	135	15.5	—	130
H11460	300 to 650	420	BA	B	50	70	8.5	—	72
H11460-01	300 to 880	420	MA	B	150	250	—	0.3	65
H11460-03	185 to 650	420	BA	U	50	70	8.5	—	72
H11460-04	185 to 880	420	MA	U	150	250	—	0.3	65
H11460-20	300 to 920	630	MA	B	350	500	—	0.45	78
H11460-100	300 to 650	400	SBA	B	90	105	13.5	—	110
H11460-200	300 to 650	400	UBA	B	110	135	15.5	—	130

Notes: (E) BA: Bialkali MA: Multialkali SBA: Super Bialkali UBA: Ultra Bialkali

(F) B: Borosilicate glass U: UV glass

(G) Measured at the peak wavelength



(at 25 °C)

Current-to-Voltage Conversion Factor (V/μA)	Frequency Bandwidth	Input Voltage (V)	Input Current Typ. (mA)	Recommended Control Voltage Adjustment Range (V)	Weight (g)	Features	Type No.
0.1	DC to 1 MHz	±11.5 to ±15.5	+26 / -18	+2.0 to +4.0	129	H9530 with preamplifier and high voltage power supply	H11451 SERIES
0.1	DC to 1 MHz	±11.5 to ±15.5	+32 / -18	+2.0 to +4.0	155	H11451 with individual gain control function	H11452 SERIES
0.1	DC to 1 MHz	±11.5 to ±15.5	+46 / -42	+2.0 to +3.2	185	H10515B with preamplifier and high voltage power supply	H11459 SERIES
0.1	DC to 1 MHz	±11.5 to ±15.5	+127 / -83	+2.0 to +3.2	246	H7260 with preamplifier, high voltage power supply and cooling fan	H11460 SERIES

Notes: ① At ±15 V input voltage

(at 25 °C)

Anode Characteristics ④				Offset Voltage Max. (mV)	Ripple Noise (peak to peak) Typ. (mV)	Cross-talk Typ. (%)	Uniformity Between Each Anode		Type No.
Luminous		Voltage Output Depending on PMT Dark Current per Channel ①					Typ.	Max.	
Min. (V/lm)	Typ. (V/lm)	Typ. (mV)	Max. (mV)						
7.5 × 10 <sup>6</sup>	7.5 × 10 <sup>7</sup>	0.05	0.5	±2	1	0.2	—	1: 1.1	H11451-01
1.75 × 10 <sup>7</sup>	1.5 × 10 <sup>8</sup>	0.1	1	±2	1	0.2	—	1: 1.1	H11451-20
7.5 × 10 <sup>6</sup>	7.5 × 10 <sup>7</sup>	0.05	0.5	±2	1	0.2	1: 1.7	1: 2.5	H11452-01
1.75 × 10 <sup>7</sup>	1.5 × 10 <sup>8</sup>	0.1	1	±2	1	0.2	1: 1.7	1: 2.5	H11452-20
5.0 × 10 <sup>6</sup>	2.8 × 10 <sup>7</sup>	0.02	0.2	±2	1	3	1: 1.5	1: 2	H11459
7.5 × 10 <sup>6</sup>	2.5 × 10 <sup>7</sup>	0.05	0.5	±2	1	3	1: 1.7	1: 2.5	H11459-01
5.0 × 10 <sup>6</sup>	2.8 × 10 <sup>7</sup>	0.02	0.2	±2	1	3	1: 1.5	1: 2	H11459-03
7.5 × 10 <sup>6</sup>	2.5 × 10 <sup>7</sup>	0.05	0.5	±2	1	3	1: 1.7	1: 2.5	H11459-04
1.75 × 10 <sup>7</sup>	5.0 × 10 <sup>7</sup>	0.1	1	±2	1	3	1: 1.7	1: 2.5	H11459-20
9.0 × 10 <sup>6</sup>	3.15 × 10 <sup>7</sup>	0.02	0.2	±2	1	3	1: 1.5	1: 2	H11459-100
1.1 × 10 <sup>7</sup>	4.05 × 10 <sup>7</sup>	0.02	0.2	±2	1	3	1: 1.5	1: 2	H11459-200
5.0 × 10 <sup>6</sup>	1.4 × 10 <sup>7</sup>	0.02	0.2	±2	1	3	1: 1.5	1: 2	H11460
7.5 × 10 <sup>6</sup>	2.5 × 10 <sup>7</sup>	0.05	0.5	±2	1	3	1: 1.7	1: 2.5	H11460-01
5.0 × 10 <sup>6</sup>	1.4 × 10 <sup>7</sup>	0.02	0.2	±2	1	3	1: 1.5	1: 2	H11460-03
7.5 × 10 <sup>6</sup>	2.5 × 10 <sup>7</sup>	0.05	0.5	±2	1	3	1: 1.7	1: 2.5	H11460-04
1.75 × 10 <sup>7</sup>	5.0 × 10 <sup>7</sup>	0.1	1	±2	1	3	1: 1.7	1: 2.5	H11460-20
9.0 × 10 <sup>6</sup>	2.1 × 10 <sup>7</sup>	0.02	0.2	±2	1	3	1: 1.5	1: 2	H11460-100
1.1 × 10 <sup>7</sup>	2.7 × 10 <sup>7</sup>	0.02	0.2	±2	1	3	1: 1.5	1: 2	H11460-200

Notes: ④ Control Voltage = H11451 Series / H11452 Series: +4 V  
H11459 Series / H11460 Series: +3.2 V

① After 30 minutes storage in darkness

# LINEAR ARRAY MULTIANODE PMT ASSEMBLIES AND MODULES

Figure 9: Sensitivity Adjustment Method

## H11451 / H11452

### VOLTAGE PROGRAMMING

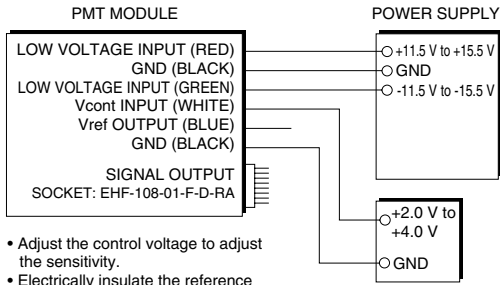

- Adjust the control voltage to adjust the sensitivity.
- Electrically insulate the reference voltage output.

### RESISTANCE PROGRAMMING

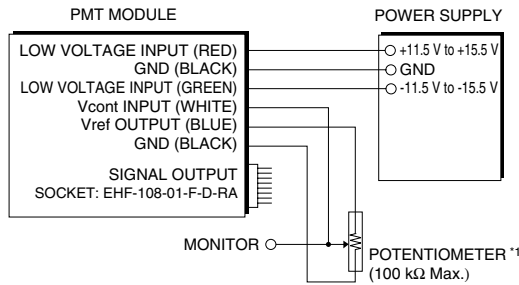

\*1: When using a potentiometer to adjust sensitivity, monitor the control voltage so that it does not exceed +4.8 V.

TPMHC0241EA

## H11459 / H11460

### VOLTAGE PROGRAMMING

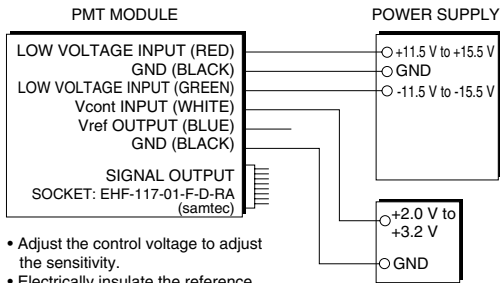

- Adjust the control voltage to adjust the sensitivity.
- Electrically insulate the reference voltage output.

### RESISTANCE PROGRAMMING

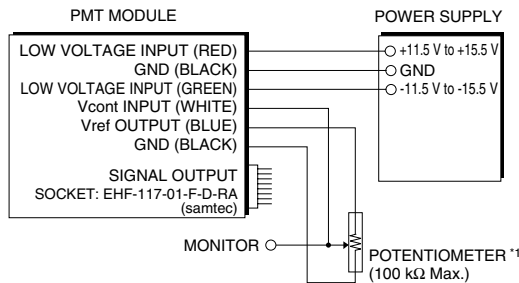

\*1: When using a potentiometer to adjust sensitivity, monitor the control voltage so that it does not exceed +3.6 V.

TPMHC0242EA

Figure 10: Dimensional Outline (Unit: mm)

## H11451

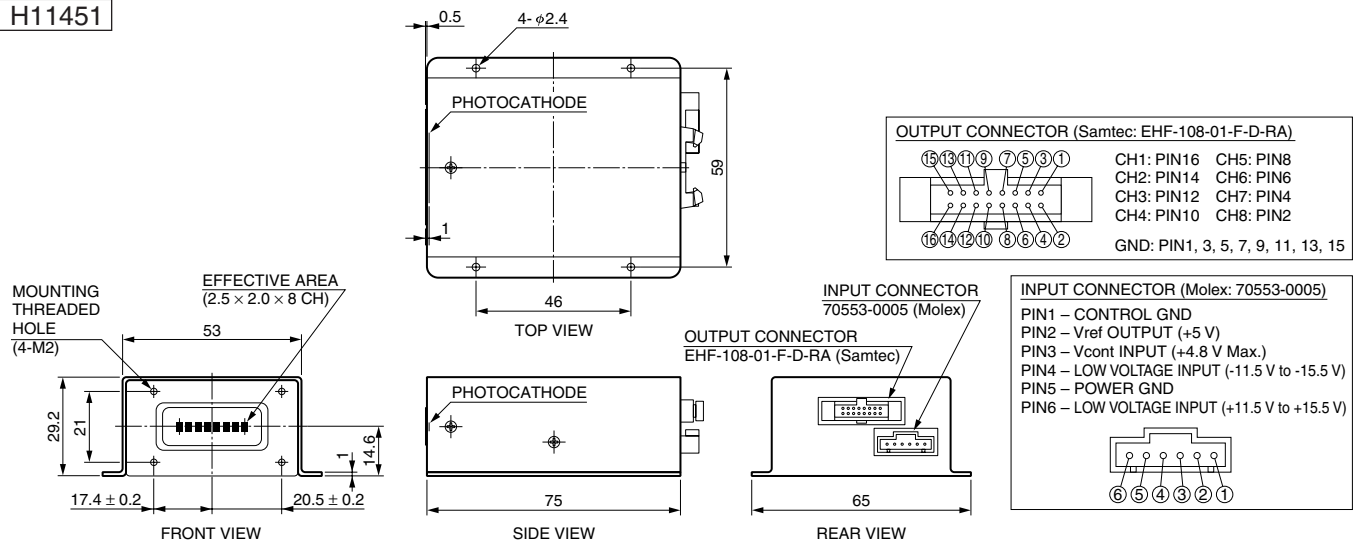

### POWER CABLE (SUPPLIED)

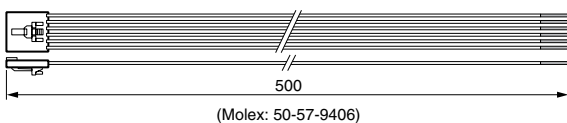

### RIBBON CABLE (SUPPLIED)

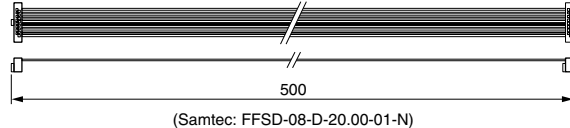

TPMHA0567EA

Figure 11: Dimensional Outline (Unit: mm)

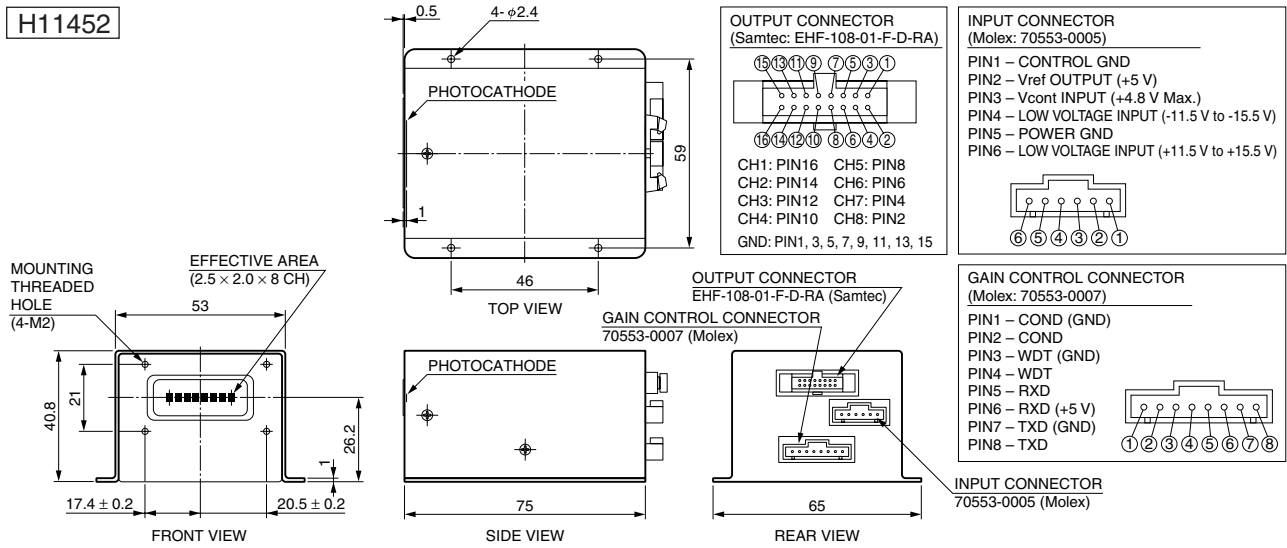

**POWER CABLE (SUPPLIED)**

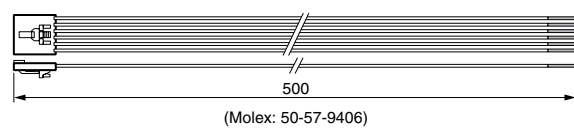

**RIBBON CABLE (SUPPLIED)**

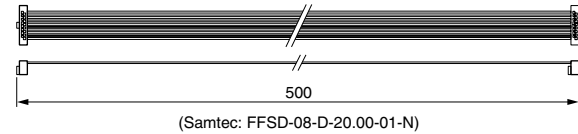

**GAIN CONTROL CABLE (SUPPLIED)**

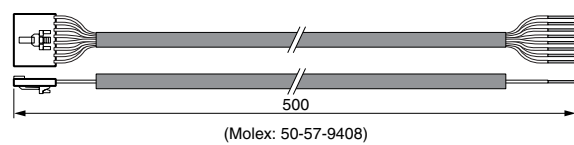

TPMHA0568EA

Figure 12: Dimensional Outline (Unit: mm)

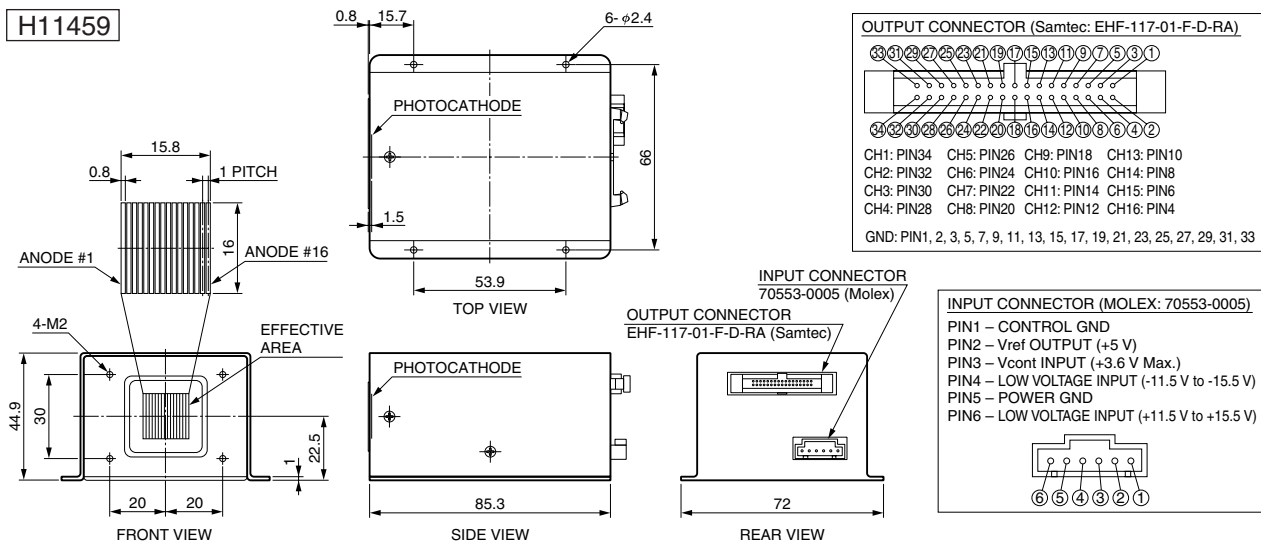

**POWER CABLE (SUPPLIED)**

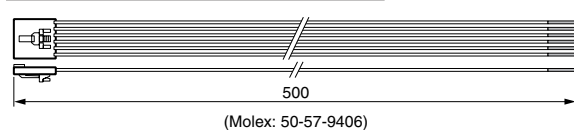

**RIBBON CABLE (SUPPLIED)**

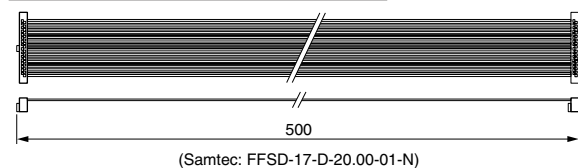

TPMHA0569EA

# LINEAR ARRAY MULTIANODE PMT ASSEMBLIES AND MODULES

Figure 13: Dimensional Outline (Unit: mm)

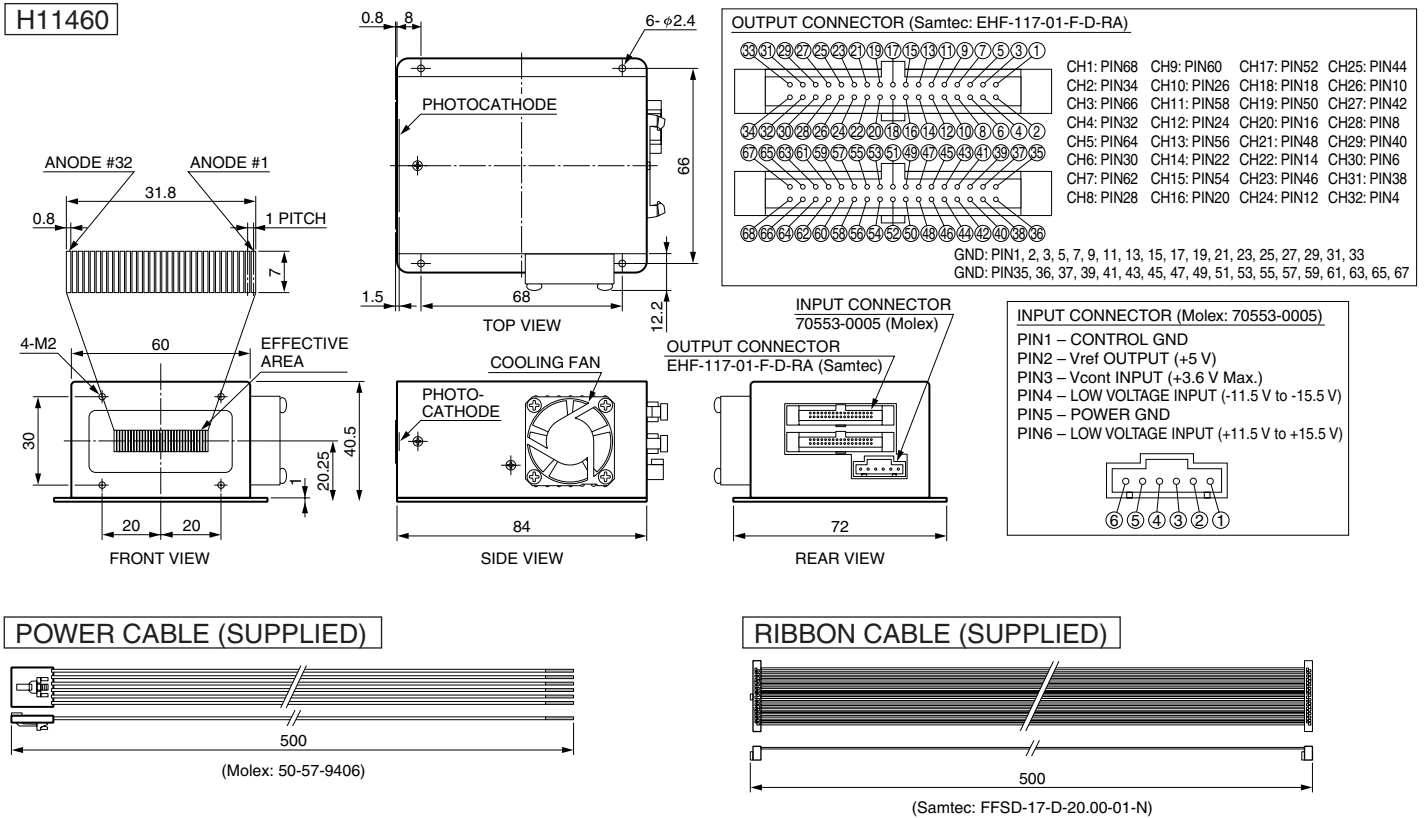

TPMHA0570EA

**⚠ WARNING ~ High Voltage ~**

The product is operated at high voltage potential. Further, the metal housing of the product is connected to the photocathode (potential) so that it becomes a high voltage potential when the product is operated at a negative high voltage (anode grounded). Accordingly, extreme safety care must be taken for the electrical shock hazard to the operator or the damage to the other instruments.

\* PATENT: USA Pat. No. 5410211      PATENT PENDING: JAPAN 12, USA 8, EUROPE 9

**HAMAMATSU PHOTONICS K.K. www.hamamatsu.com**

**HAMAMATSU PHOTONICS K.K., Electron Tube Division**

314-5, Shimokanzo, Iwata City, Shizuoka Pref., 438-0193, Japan, Telephone: (81)539/62-5248, Fax: (81)539/62-2205

U.S.A.: Hamamatsu Corporation: 360 Foothill Road, Bridgewater, N.J. 08807-0910, U.S.A., Telephone: (1)908-231-0960, Fax: (1)908-231-1218 E-mail: usa@hamamatsu.com

Germany: Hamamatsu Photonics Deutschland GmbH: Arzbergerstr. 10, D-82211 Herrsching am Ammersee, Germany, Telephone: (49)8152-375-0, Fax: (49)8152-2658 E-mail: info@hamamatsu.de

France: Hamamatsu Photonics France S.A.R.L.: 19, Rue du Saule Trapu, Parc du Moulin de Massy, 91882 Massy Cedex, France, Telephone: (33)1 69 53 71 00, Fax: (33)1 69 53 71 10 E-mail: infos@hamamatsu.fr

United Kingdom: Hamamatsu Photonics UK Limited: 2 Howard Court, 10 Tewin Road, Welwyn Garden City, Hertfordshire AL7 1BW, United Kingdom, Telephone: (44)1707-294888, Fax: (44)1707-325777 E-mail: info@hamamatsu.co.uk

North Europe: Hamamatsu Photonics Norden AB: Torshamnsgatan 35 SE-164 40 Kista, Sweden, Telephone: (46)8-509-031-00, Fax: (46)8-509-031-01 E-mail: info@hamamatsu.se

Italy: Hamamatsu Photonics Italia S.r.l.: Strada della Moia, 1 int. 6, 20020 Arese (Milano), Italy, Telephone: (39)02-93581733, Fax: (39)02-93581741 E-mail: info@hamamatsu.it

China: Hamamatsu Photonics (China) Co., Ltd.: B1201 Jiaming Center, No.27 Dongsanhuan Bellu, Chaoyang District, Beijing 100020, China, Telephone: (86)10-6586-6006, Fax: (86)10-6586-2866 E-mail: hpc@hamamatsu.com.cn

TPMH1325E02  
MAY 2015 IP