

Metal Package PMT with Cooler

Photosensor Modules H7422 Series



Heatsink with fan (A7423) sold separately

The H7422 series are photosensor modules with an internal high-voltage power supply circuit and a cooler installed to the metal package photomultiplier tube. Efficient cooling was achieved by placing the cooler near the photomultiplier tube to reduce thermal noise emitted from the photocathode and a high S/N ratio can be obtained even at extremely low light levels.

The H7422-40 has high sensitivity in the 300 nm to 720 nm wavelengths. The H7422-50 is sensitive along a wide spectral range from 380 nm to 890 nm. The photomultiplier tube is maintained at a constant temperature by monitoring the output from a thermistor installed near the photomultiplier and then regulating the current to the thermoelectric cooler.

Product Variations

Type No.	Spectral Response	Max. Output Signal Current	Features	
H7422-40	300 nm to 720 nm	2 μ A	GaAsP photocathode, QE 40 % at peak wavelength, high gain (P type)	For photon counting
H7422P-40				
H7422-50	380 nm to 890 nm		GaAs photocathode, QE 12 % at peak wavelength, high gain (P type)	For photon counting
H7422P-50				

This product can't be used at vacuum environment or reduced pressure environment.

Specifications

(at +25 °C)

Parameter				H7422-40	H7422-50	Unit		
Input Voltage				+11.5 to +15.5		V		
Max. Input Voltage for Main Unit				+18		V		
Max. Input Current for Main Unit				62		mA		
Max. Input Voltage for Thermoelectric Cooler				2.6		V		
Max. Input Current for Thermoelectric Cooler				2.2		A		
Max. Output Signal Current				2		μ A		
Max. Control Voltage				+0.9 (Input impedance 100 k Ω)		V		
Recommended Control Voltage Adjustment Range				+0.5 to +0.8		V		
Effective Area				ϕ 5		mm		
Sensitivity Adjustment Range				1: 50		—		
Peak Sensitivity Wavelength				580	800	nm		
Cathode	Radiant Sensitivity	Typ.	420 nm	108	15	mA/W		
			550 nm	176	50			
			800 nm	—	90			
Anode	Standard Type	Radiant Sensitivity *1	Typ.	550 nm	8.8×10^4	2.5×10^4	A/W	
				Dark Current *1 *2	Typ.	0.4	0.5	nA
	Max.	1.0	1.3					
	P Type	Radiant Sensitivity *3	Typ.	550 nm	1.8×10^5	5.0×10^4	A/W	
				Dark Count *2 *3	Typ.	100	125	s ⁻¹
					Max.	300	375	
Rise Time *1			Typ.	1.00		ns		
Ripple Noise *1 *4 (peak to peak)			Max.	0.6		mV		
Settling Time *5			Typ.	0.2		s		
Operating Ambient Temperature *6				+5 to +35		°C		
Storage Temperature *6				-20 to +50		°C		
Weight				Approx. 400		g		

*1: Control voltage = +0.8 V PMT setting temperature 0 °C, used with C8137-02 and A7423

*2: After 30 minutes storage in darkness

*3: Plateau voltage = control voltage, PMT setting temperature 0 °C, used with C8137-02 and A7423

*4: Cable RG-174/U, Cable length 450 mm, Load resistance = 1 M Ω , Load capacitance = 22 pF

*5: The time required for the output to reach a stable level following a change in the control voltage from +1.0 V to +0.5 V.

*6: No condensation

Current Output Type Photosensor Modules

Cooling Specifications

Parameter	H7422 Series	Unit
Cooling Method	Thermoelectric cooling	—
Max. Cooling Temperature (ΔT) *7	35	°C
Cooling Time *7	Approx. 5	min

*7: Input current to thermoelectric cooler=2 A

Characteristics (Cathode radiant sensitivity, Gain)

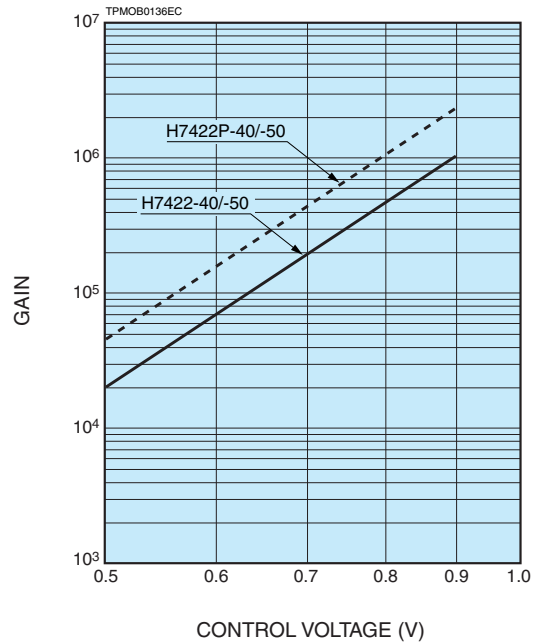
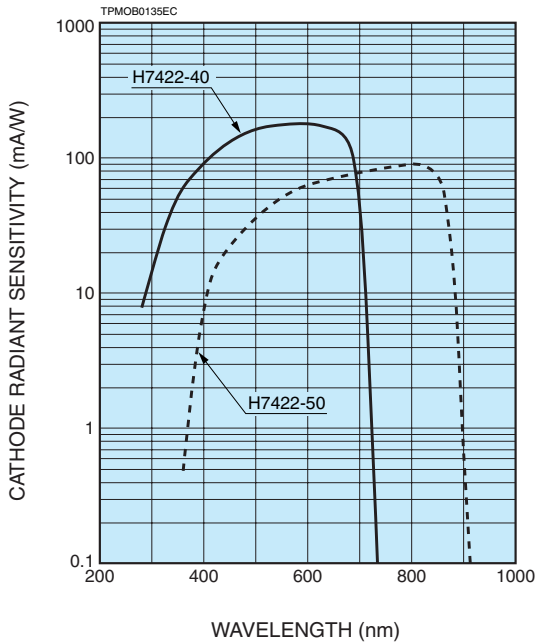

Block Diagram

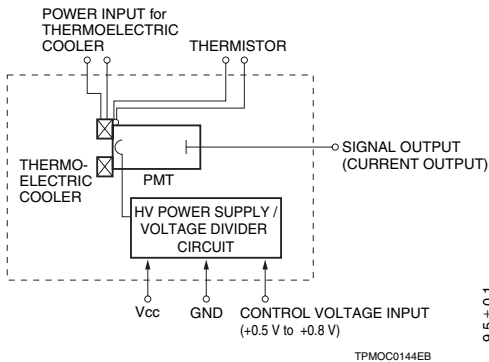

In order to protect the PMT module from being damaged by excessive light, the H7422-40/50 has a protective function circuit. The circuit automatically turns off high voltage if the output current exceeds the preset current limit (approx. 10 μ A). This protection circuit works whenever the preset current limit is exceeded, even for a short moment. An example of this function could be in applications such as laser scanning microscopes where the output current may momentarily exceed the preset current limit. This will trigger the protection circuit and interrupt measurement. In such applications, if the average output current is lower than the PMT module maximum rating (2 μ A), we can change the current limit in the protection circuit up to approximately 50 μ A. This means that PMT module operation continues without turning off high voltage even if a momentary high output occurs. Users can choose this option when ordering.

Dimensional Outlines (Unit: mm)

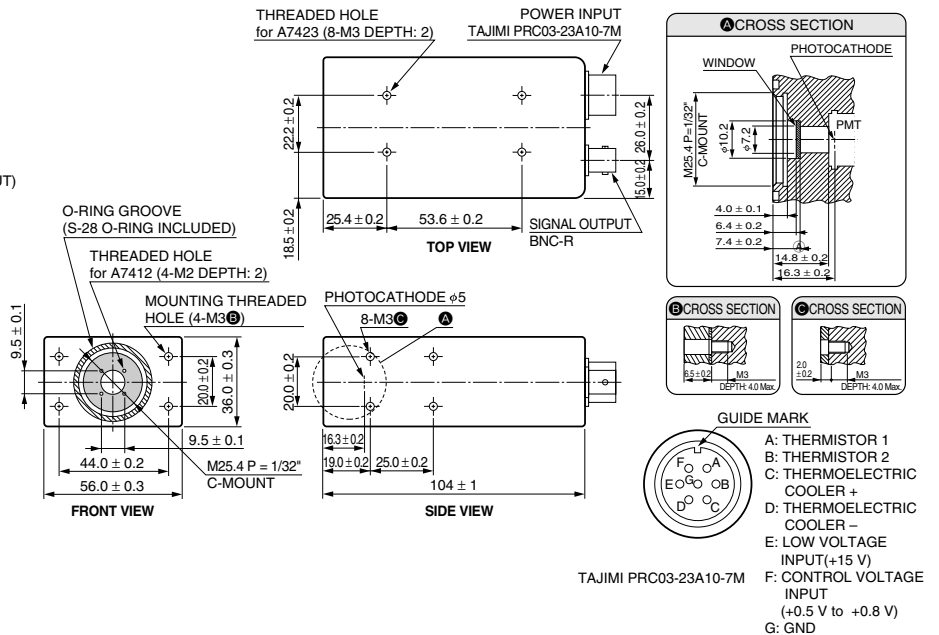

Metal Package PMT with Cooler

H7422 Series Option

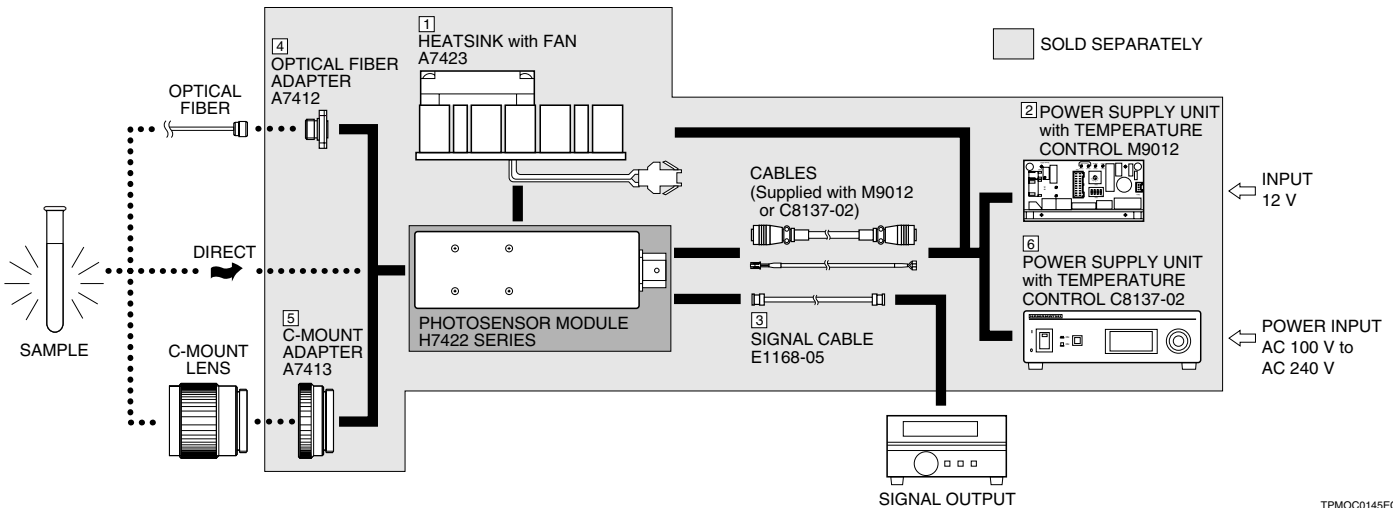

● Heatsink with Fan A7423

The temperature of the H7422 outer case rises due to the thermoelectric cooler housed in the case. The A7423 heatsink efficiently radiates away this heat to prevent a temperature rise in the H7422. The A7423 can be easily installed onto the H7422 with four M3 screws. Apply a heat conductive grease onto the joint surface shared by the H7422 and A7423.

Parameter	Value	Unit
Input Voltage	12	V
Input Current	During Lock	140 mA
	During Operation	90 mA
Operating Voltage	10.2 to 13.8	V
Weight	120	g

● Power Supply Unit with Temperature Control M9012

The M9012 is an on-board type power supply unit. By just connecting to 12 V supply, the M9012 provides power necessary to operate the H7422 series. The M9012 also controls the thermoelectric cooler in the H7422 series so that the output and noise can be maintained at constant levels even when the ambient temperature changes. The thermoelectric cooler and PMT operation can be controlled from an external device by connecting it to the I/O connector on the M9012.

Parameter	Description / Value	Unit
Max. Cooling Temperature (ΔT)	35	$^{\circ}\text{C}$
Input Voltage	12	V
Max. Input Current	1.2	A
Max. Power Consumption	15.8	V·A
Main Circuit Output Voltage	12	V
Max. Output Current for Thermoelectric Cooler	2.2	A
Output Voltage for Fan	12	V
Max. Control Output Voltage	1.26	V
Max. Control Input Voltage	0.9	V
Control Signal	Thermoelectric Cooler	Non-insulated TTL level input
	PMT	Non-insulated TTL level input
	Fan	Non-insulated TTL level input
Error Signal	Thermoelectric Cooler	Non-insulated TTL level output
	PMT	Non-insulated TTL level output
	PMT	5
LED Output	PMT	5
	Error	5
Setting Cooling Temperature	0	$^{\circ}\text{C}$
Weight (excluding cables)	120	g

● Signal Cable E1168-05

This signal cable is terminated with a BNC connector for easily connecting the H7422 to external equipment.

● Optical Fiber Adapter (FC Type) A7412

The A7412 is an FC type optical fiber connector that attaches to the light input window of the H7422. The A7412 can easily be secured in place with four M2 screws.

● C-mount Adapter A7413

The A7413 mount adapter is used when a C-mount lens protruding 4 mm or more from the flange-back must be installed onto the H7422.

● Power Supply Unit with Temperature Control C8137-02

The C8137-02 is a power supply unit with a temperature control function. Just connecting to an AC source of 100 V to 240 V generates the output voltages for the thermoelectric cooler and the A7423 fan, needed for operating the H7422. The photomultiplier tube temperature can be maintained to 0°C by monitoring the thermistor and regulating the output current for the thermoelectric cooler. Control voltage can be varied by a knob on the front panel.

Parameter	Value	Unit
Max. Cooling Temperature (ΔT)	35	$^{\circ}\text{C}$
Setting Cooling Temperature (preset at factory)	0	$^{\circ}\text{C}$
AC Input Voltage	100 to 240	V
Input Voltage Frequency	50 / 60	Hz
Power Consumption	30	V·A
Main Circuit Output Voltage	+15	V
Max. Current for Thermoelectric Cooler	2.2	A
Output Voltage for Fan	12	V
Control Voltage Adjustment Range	0 to +0.9	V
Weight	1.1	kg

Current Output Type Photosensor Modules H7422 Series

Options (Unit: mm)

1 Heatsink with Fan A7423

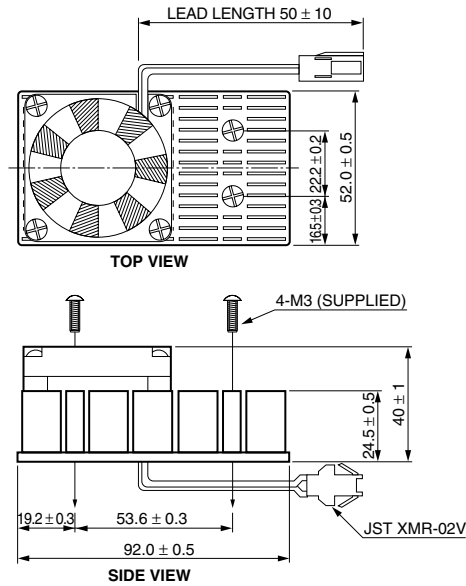

TACCA0188ED

2 Power Supply Unit with Temperature Control M9012

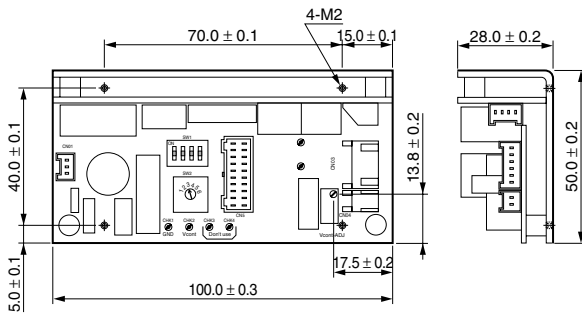

FAN CABLE

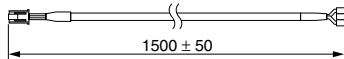

MODULE CABLE

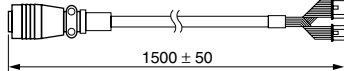

POWER CABLE

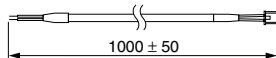

EXTERNAL I/O CABLE

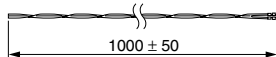

EXTERNAL I/O HOUSING



TACCA0251EA

3 Signal Cable E1168-05

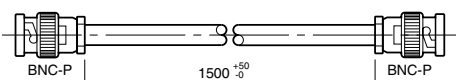

TACCA0148EA

4 Optical Fiber Adapter (FC Type) A7412

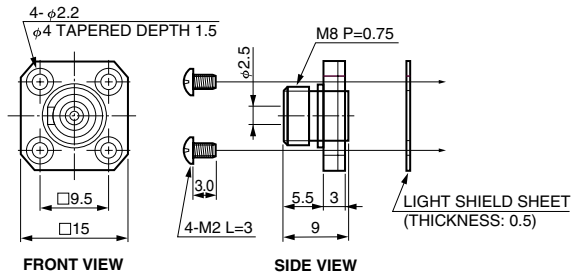

TACCA0190EB

5 C-mount Adapter A7413

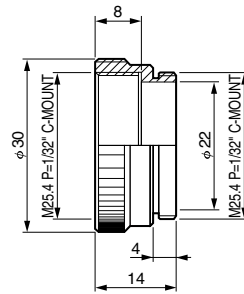

TACCA0191EA

6 Power Supply Unit with Temperature Control C8137-02

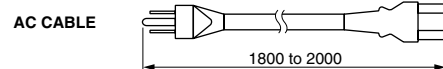
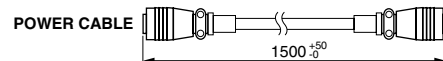
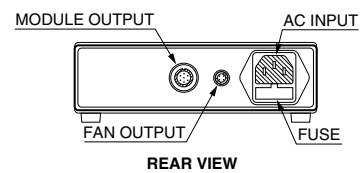
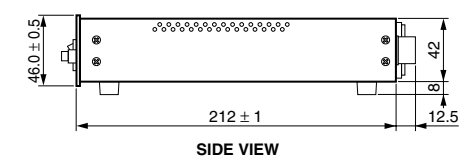
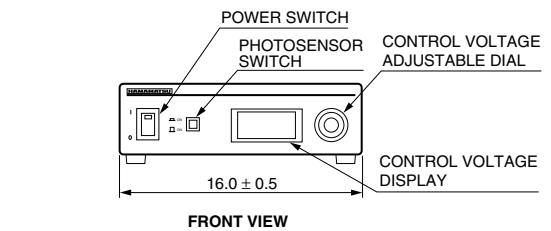

TACCA0238EB