

MPPC® modules

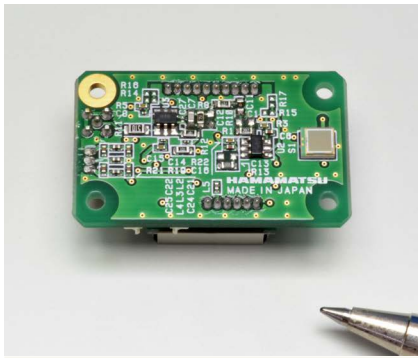

C15522 series

Optical measurement modules for low-level light detection, analog output

The C15522 series are optical measurement modules capable of detecting low level light using its built-in MPPC that features wide dynamic range. These modules consist of an MPPC, a signal amplifier circuit, a high-voltage power supply circuit, and a temperature compensation circuit. The photosensitive area is available in two sizes of 1.3 × 1.3 mm and 3 × 3 mm, and the signal output is analog. Modules operate just by connecting them to an external power supply (±5 V).

Features

- Built-in wide dynamic range type MPPC
- High sensitivity in the short wavelength range
- Low noise equivalent power
- Built-in temperature compensation circuit
- Compact and lightweight
- Analog output

Applications

- Flow cytometry
- Low-level-light measurement
- Fluorescence measurement
- Analytical instrument

Structure

Parameter	Symbol	C15522-1310SA	C15522-1315SA	C15522-3010SA	C15522-3015SA	Unit
Effective photosensitive area	-	1.3 × 1.3		3 × 3		mm
Pixel pitch	-	10	15	10	15	µm
Number of pixels	-	16663	7284	89984	39984	-

Absolute maximum ratings

Parameter	Symbol	Condition	Value	Unit
Supply voltage	Vs		±6	V
Operating temperature	Topr	No dew condensation*1	-10 to +60	°C
Storage temperature	Tstg	No dew condensation*1	-20 to +80	°C

*1: When there is a temperature difference between a product and the surrounding area in high humidity environment, dew condensation may occur on the product surface. Dew condensation on the product may cause deterioration in characteristics and reliability.

Note: Exceeding the absolute maximum ratings even momentarily may cause a drop in product quality. Always be sure to use the product within the absolute maximum ratings.

Electrical and optical characteristics (Typ. Ta=25 °C, λ=λp, Vs=±5 V, unless otherwise noted)

Parameter	Symbol	Condition	C15522-1310SA			C15522-1315SA			C15522-3010SA			C15522-3015SA			Unit
			Min.	Typ.	Max.	Min.	Typ.	Max.	Min.	Typ.	Max.	Min.	Typ.	Max.	
Spectral response range	λ		290 to 900			290 to 900			290 to 900			290 to 900			nm
Peak sensitivity wavelength	λp		-	500	-	-	500	-	-	500	-	-	500	-	nm
Temperature stability of output voltage	-	Ta=25 ± 10 °C	-	-	±5	-	-	±5	-	-	±5	-	-	±5	%
Photoelectric sensitivity	-		0.3 × 10 ⁸	0.4 × 10 ⁸	0.5 × 10 ⁸	0.7 × 10 ⁸	1.0 × 10 ⁸	1.3 × 10 ⁸	0.3 × 10 ⁸	0.4 × 10 ⁸	0.5 × 10 ⁸	0.7 × 10 ⁸	1.0 × 10 ⁸	1.3 × 10 ⁸	V/W
Cutoff frequency	High band	-3 dB, sine wave	10	15	-	7	10	-	10	15	-	7	10	-	MHz
	Low band		DC			DC			DC			DC			-
Noise equivalent power	NEP	Dark state	-	1.2	2.4	-	0.8	1.6	-	2.7	5.4	-	1.8	3.6	fW/Hz ^{1/2}
Minimum detection limit	-	Dark state	-	5.4	10.8	-	2.5	5.0	-	10	20	-	57	11.4	pW rms
Maximum output voltage	-		-	4.7	-	-	4.7	-	-	4.7	-	-	4.7	-	V

Electrical characteristics

Parameter	Symbol	Condition	Min	Typ	Max	Unit
Supply voltage*2	+Vs		+4.75	+5	+5.25	V
	-Vs		-4.75	-5	-5.25	
Current consumption	Ic	+Vs	-	+50	+250	mA
		-Vs	-	-20	-40	

*2: A power supply with 300 mA or higher output must be used.

Block diagram

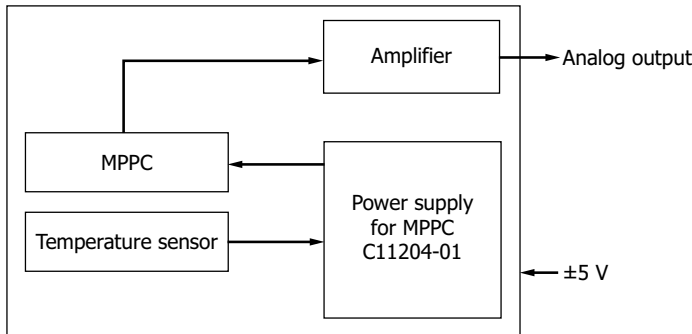

KACCC0675EA

Connection example

Using the supplied power cable, connect the MPPC module to a power supply. You can monitor the output waveform by connecting the MPPC module to an oscilloscope.

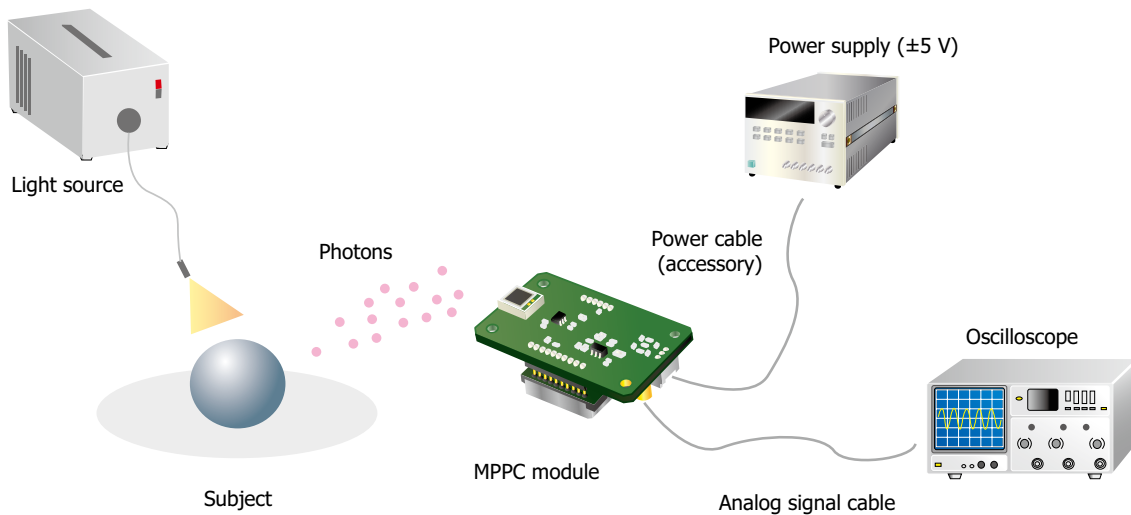

KACCC1002EA

Measurement example

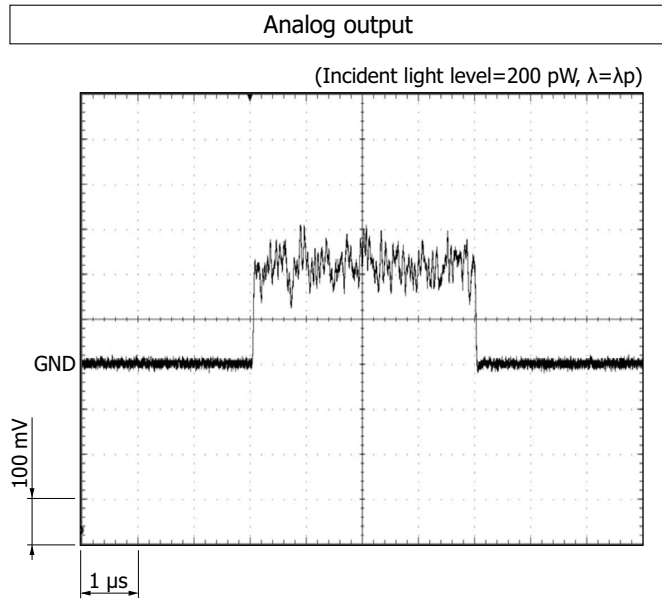

Photoelectric sensitivity vs. wavelength

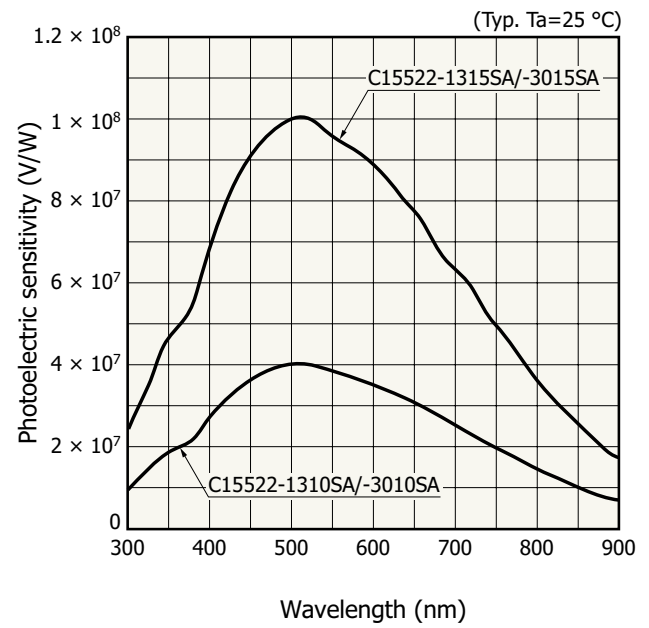

KACCB0580EA

Frequency response (typical example)

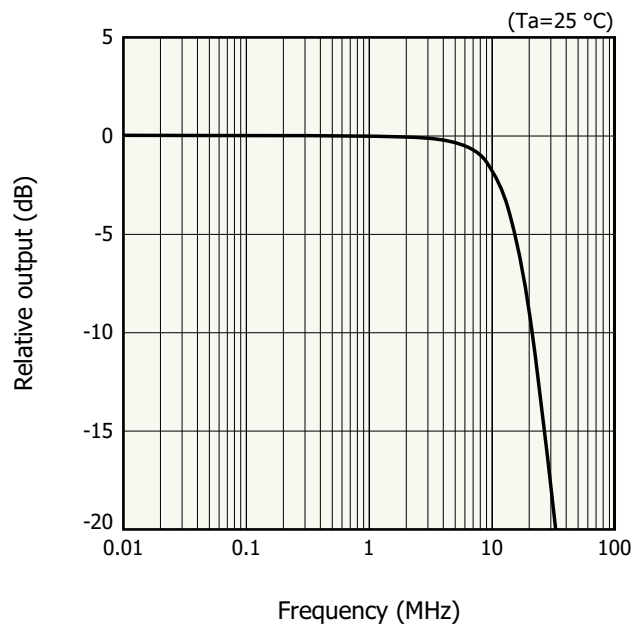

KACCB0652EA

Linearity

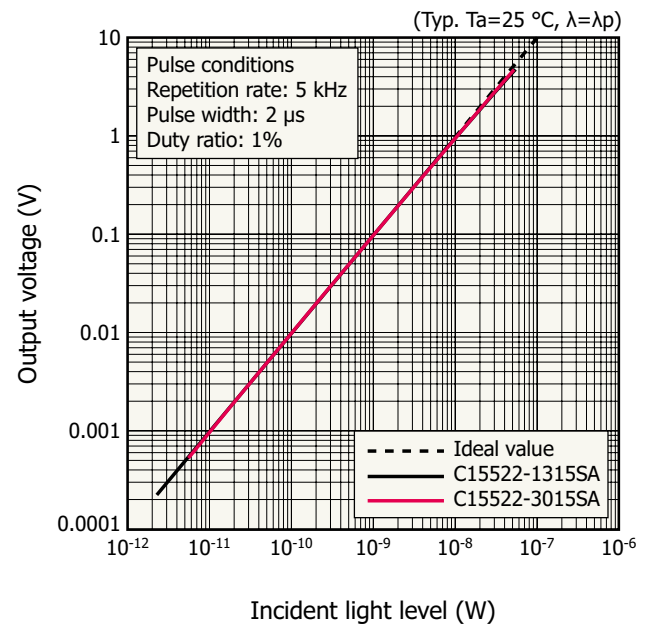

KACCB0581EA

Dimensional outlines (unit: mm)

C15522-1310SA/-1315SA

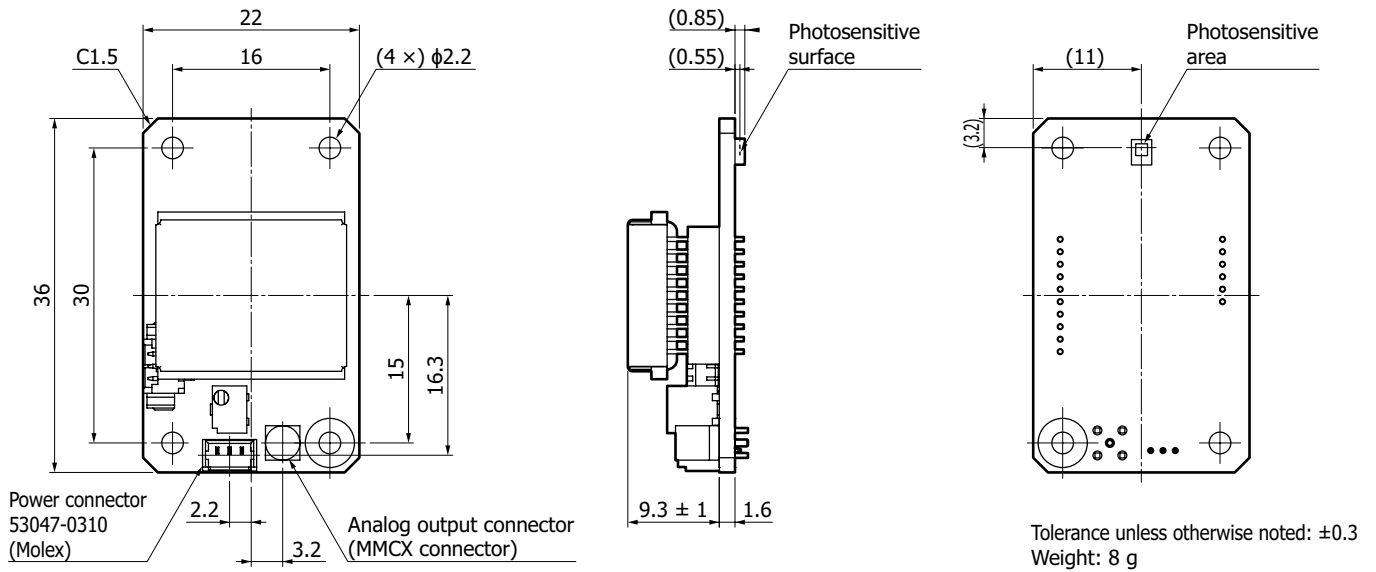

C15522-3010SA/-3015SA

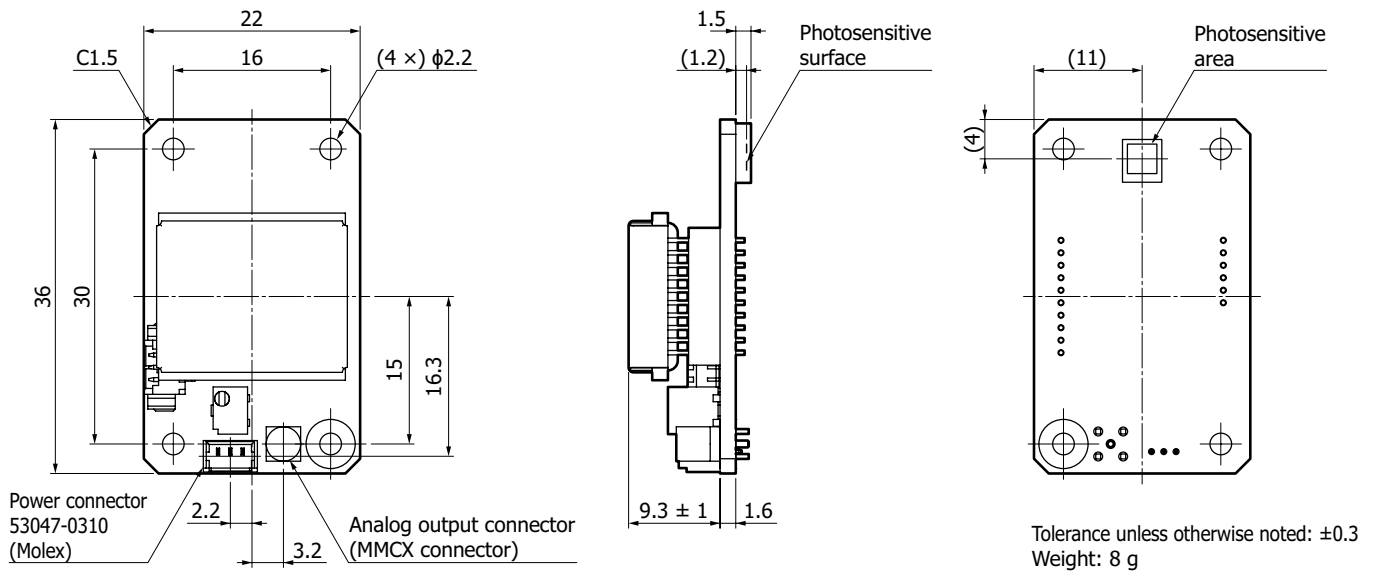

Accessories

- Power cable
- Instruction manual

Options (sold separately)

MMCX-BNC cable A12763

Dimensional outline (unit: mm)

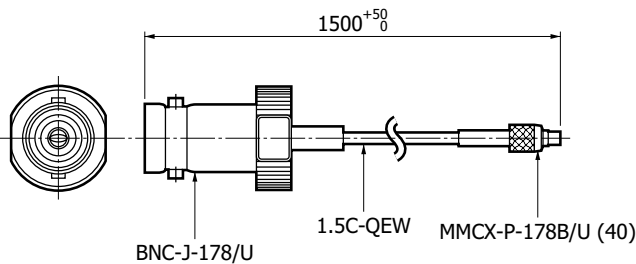

KACCA0358EA

Related products

MPPC modules C15524 series

The C15524 series are optical measurement modules with an MPPC that can detect low-level light. These modules consist of an MPPC, an amplifier, a high-voltage power supply circuit, and a temperature compensation circuit. The signal output is analog. The MPPC of the C15524 series has a flexible cable, but that of the C15522 series is mounted on the circuit board.



Related information

www.hamamatsu.com/sp/ssd/doc_en.html

- Precautions
- Disclaimer

MPPC is a registered trademark of Hamamatsu Photonics K.K.
Information described in this material is current as of June 2021.

Product specifications are subject to change without prior notice due to improvements or other reasons. This document has been carefully prepared and the information contained is believed to be accurate. In rare cases, however, there may be inaccuracies such as text errors. Before using these products, always contact us for the delivery specification sheet to check the latest specifications.

The product warranty is valid for one year after delivery and is limited to product repair or replacement for defects discovered and reported to us within that one year period. However, even if within the warranty period we accept absolutely no liability for any loss caused by natural disasters or improper product use. Copying or reprinting the contents described in this material in whole or in part is prohibited without our prior permission.

HAMAMATSU

www.hamamatsu.com

HAMAMATSU PHOTONICS K.K., Solid State Division

1126-1 Ichino-cho, Higashi-ku, Hamamatsu City, 435-8558 Japan, Telephone: (81)53-434-3311, Fax: (81)53-434-5184

U.S.A.: Hamamatsu Corporation, 360 Foothill Road, Bridgewater, N.J. 08807, U.S.A., Telephone: (1)908-231-0960, Fax: (1)908-231-1218, E-mail: usa@hamamatsu.com

Germany: Hamamatsu Photonics Deutschland GmbH: Arzbergerstr. 10, D-82211 Herrsching am Ammersee, Germany, Telephone: (49)8152-375-0, Fax: (49)8152-265-8, E-mail: info@hamamatsu.de

France: Hamamatsu Photonics France S.A.R.L.: 19, Rue du Saule Trapu, Parc du Moulin de Massy, 91882 Massy Cedex, France, Telephone: (33)1 69 53 71 00, Fax: (33)1 69 53 71 10, E-mail: infos@hamamatsu.fr

United Kingdom: Hamamatsu Photonics UK Limited: 2 Howard Court, 10 Tewin Road, Welwyn Garden City, Hertfordshire AL7 1BW, UK, Telephone: (44)1707-294888, Fax: (44)1707-325777, E-mail: info@hamamatsu.co.uk

North Europe: Hamamatsu Photonics Norden AB: Torshamnsgatan 35 16440 Kista, Sweden, Telephone: (46)8-509 031 00, Fax: (46)8-509 031 01, E-mail: info@hamamatsu.se

Italy: Hamamatsu Photonics Italia S.r.l.: Strada della Moia, 1 int. 6, 20044 Arese (Milano), Italy, Telephone: (39)02-93 58 17 33, Fax: (39)02-93 58 17 41, E-mail: info@hamamatsu.it

China: Hamamatsu Photonics (China) Co., Ltd.: 1201 Tower B, Jiaming Center, 27 Dongsanhuan Beilu, Chaoyang District, 100020 Beijing, P.R.China, Telephone: (86)10-6586-6006, Fax: (86)10-6586-2866, E-mail: hpc@hamamatsu.com.cn

Taiwan: Hamamatsu Photonics Taiwan Co., Ltd.: 8F-3, No. 158, Section2, Gongdao 5th Road, East District, Hsinchu, 300, Taiwan R.O.C. Telephone: (886)3-659-0080, Fax: (886)3-659-0081, E-mail: info@hamamatsu.com.tw