

[GA type]

C13852 series

Optical measurement modules for low-level light detection, analog output

The C13852 series (GA type) are optical measurement modules with built-in TE-cooled type MPPCs, capable of detecting low-level light. These modules consist of a thermoelectrically cooled MPPC, an amplifier, a high-voltage power supply circuit, and a temperature control circuit. The photosensitive area is available in two sizes of 1.3 × 1.3 mm and 3 × 3 mm, and the signal output is analog. The modules operate by supplying an external power supply (±5 V). As this product is compact and lightweight, it is suitable for integration into devices.

Features

- High sensitivity in the short wavelength range
- Low noise equivalent power
- Built-in temperature control function
- Analog output

Applications

- Low-level light measurement
- Flow cytometry
- Fluorescence measurement
- Analytical instruments

Structure

Parameter	Symbol	C13852-1350GA	C13852-3050GA	Unit
Built-in MPPC	-	S13362-1350DG	S13362-3050DG	-
Effective photosensitive area	-	1.3 × 1.3	3 × 3	mm
Pixel pitch	-	50		μm
Number of pixels	-	667	3600	-

Absolute maximum ratings

Parameter	Symbol	Condition	Value	Unit
Supply voltage	Vs		±6	V
Operating temperature	T _{opr}	No dew condensation*1	-10 to +40	°C
Storage temperature	T _{stg}	No dew condensation*1	-20 to +70	°C

*1: When there is a temperature difference between a product and the surrounding area in high humidity environment, dew condensation may occur on the product surface. Dew condensation on the product may cause deterioration in characteristics and reliability.

Note: Exceeding the absolute maximum ratings even momentarily may cause a drop in product quality. Always be sure to use the product within the absolute maximum ratings.

Recommended operating conditions

Parameter	Symbol	Condition	Min.	Typ.	Max.	Unit
Supply voltage*2	+Vs	Positive power supply	+4.75	+5	+5.25	V
	-Vs	Negative power supply	-4.75	-5	-5.25	

*2: A power supply with 2 A or higher output must be used.

Electrical and optical characteristics (Ta=25 °C, λ=λp, Vs=±5 V, unless otherwise noted)

Parameter	Symbol	Condition	C13852-1350GA			C13852-3050GA			Unit	
			Min.	Typ.	Max.	Min.	Typ.	Max.		
Spectral response range	λ		320 to 900			320 to 900			nm	
Peak sensitivity wavelength	λp		-	500	-	-	500	-	nm	
Chip temperature (setting temperature) ^{*3 *4}	Tchip		-	-20	-	-	-20	-	°C	
Photoelectric sensitivity	-		0.7 × 10 ⁹	1.0 × 10 ⁹	1.3 × 10 ⁹	0.7 × 10 ⁹	1.0 × 10 ⁹	1.3 × 10 ⁹	V/W	
Cutoff frequency	High band	fc	-3 dB, sine wave	3	4	-	3	4	-	MHz
	Low band			DC			DC			-
Rise time	tr	10% to 90%, 1 p.e.	-	5	-	-	9	-	ns	
Noise equivalent power	NEP	Dark state	-	0.1	0.2	-	0.15	0.3	fW/Hz ^{1/2}	
Minimum detection limit	-	Dark state	-	0.25	0.5	-	0.35	0.7	pW rms	
Maximum output voltage	-		-	4.7	-	-	4.7	-	V	
Current consumption	Ic	+5 V	-	+200	+1500	-	+200	+1500	mA	
		-5 V	-	-20	-40	-	-20	-40		

*3: When the chip temperature strays from the setting temperature by 5 °C, cooling automatically stops, and signals are no longer output.

*4: The setting temperature cannot be changed.

Block diagram

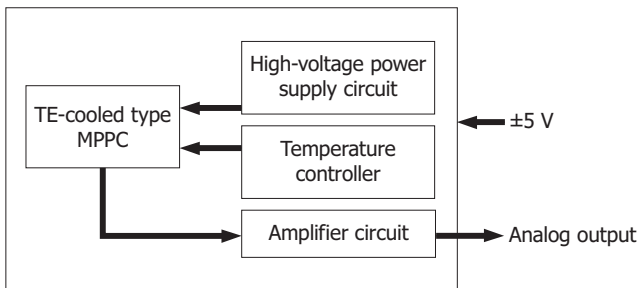

KACCC0926EA

Connection example

Using the supplied power cable, connect the MPPC module to a power supply. You can observe the MPPC module's output waveform by connecting the module to an oscilloscope.

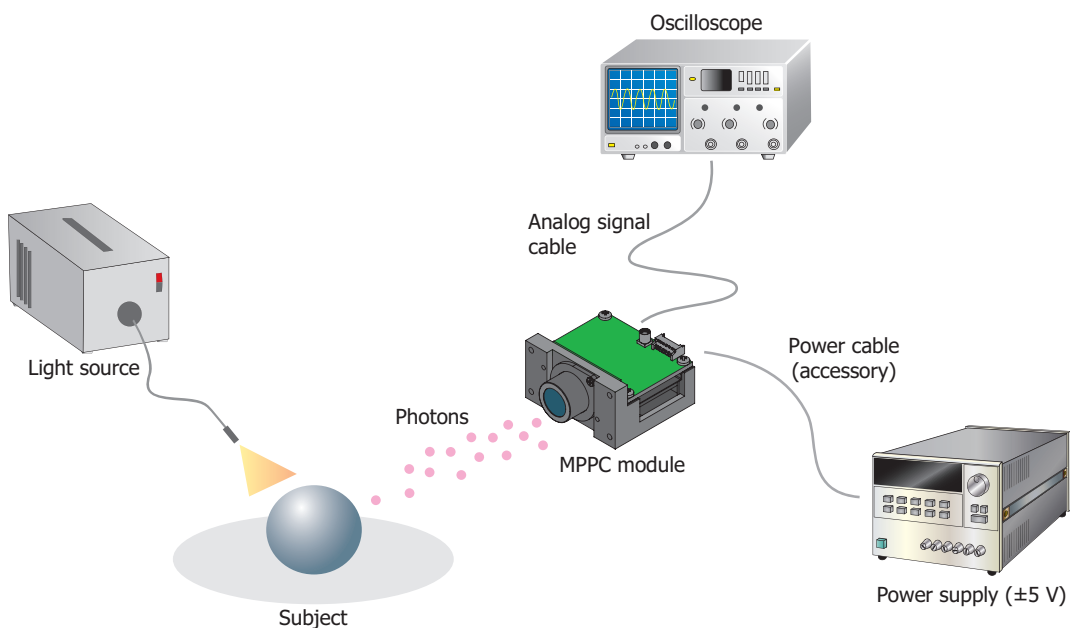

KACCC0927EA

Measurement example

Analog output

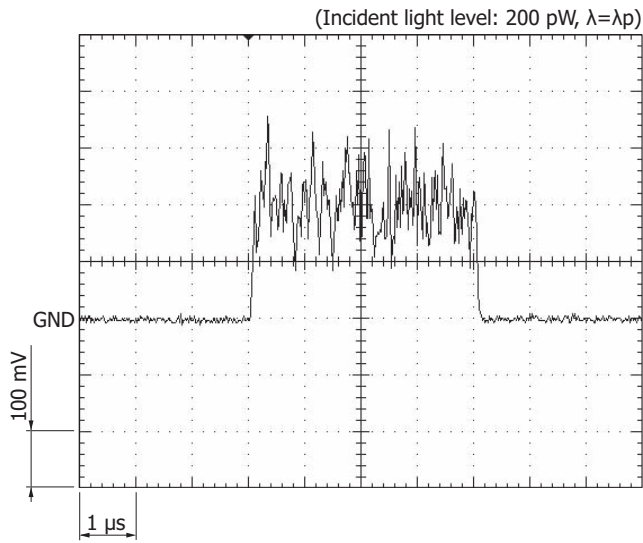

Photoelectric sensitivity vs. wavelength

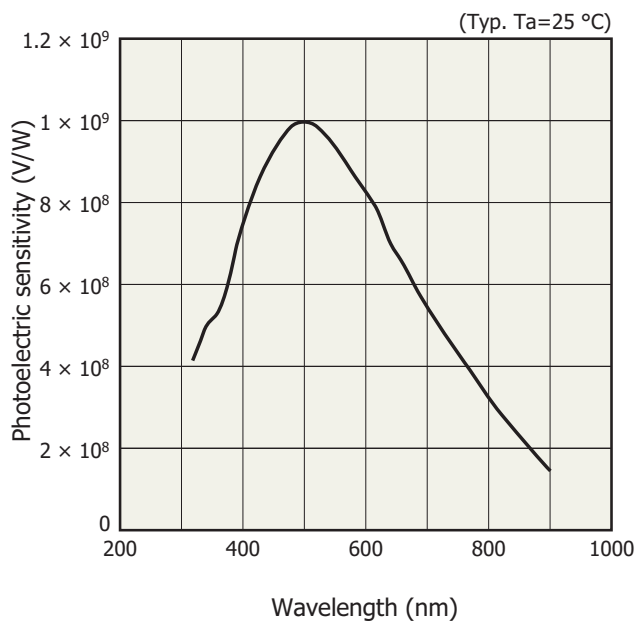

KACCB0391EB

Frequency characteristics (typical example)

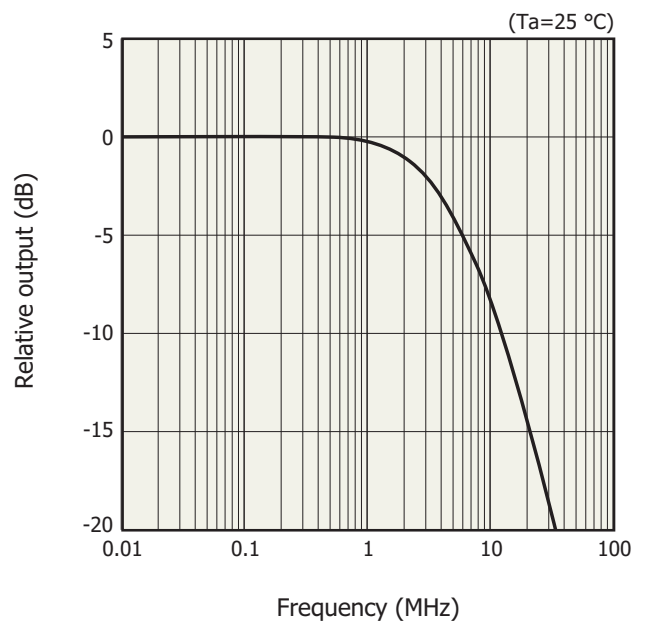

KACCB0392EA

▣ Linearity

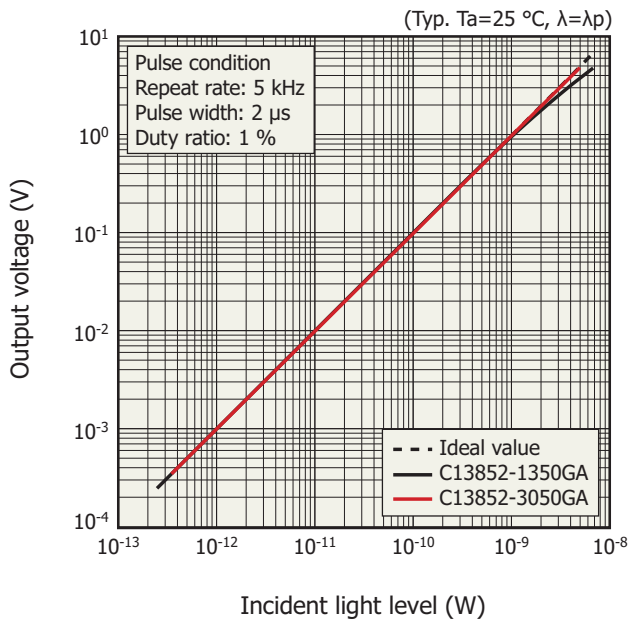

KACCB0548EA

▣ Dimensional outline (unit: mm)

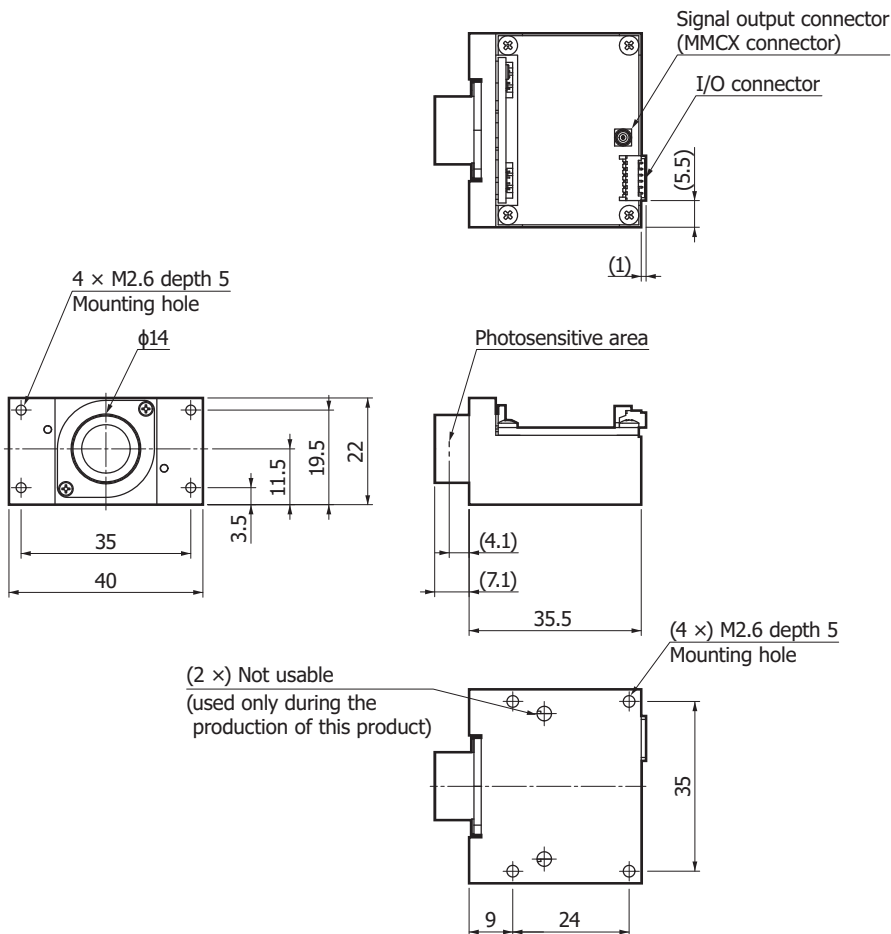

KACCA0426EA

Note: When using this product, provide heat dissipation measures by using heatsinks or through thermal coupling with the enclosure that you will use. Keep the thermal resistance to 3 $^\circ\text{C}/\text{W}$ or less.

Accessories

- Power cable
- Instruction manual

Precautions

- Use the product by referring to the supplied instruction manual.

Related products

MPPC modules C13366 series (GA type)

The C13366 series (GA type) is a module for evaluating thermoelectrically cooled MPPCs. These modules consist of a thermoelectrically cooled MPPC, an amplifier, a high-voltage power supply circuit, and a temperature control circuit. The photosensitive area is available in two sizes of 1.3 × 1.3 mm and 3 × 3 mm, and the signal output is analog. The modules operate by supplying an external power supply (±5 V). The C13366 series has nearly the same functions as the C13852 series. The C13366 series does not require heat dissipation measures.



Related information

www.hamamatsu.com/sp/ssd/doc_en.html

Precautions

- Disclaimer

MPPC is a registered trademark of Hamamatsu Photonics K.K.

Information described in this material is current as of December 2019.

Product specifications are subject to change without prior notice due to improvements or other reasons. This document has been carefully prepared and the information contained is believed to be accurate. In rare cases, however, there may be inaccuracies such as text errors. Before using these products, always contact us for the delivery specification sheet to check the latest specifications.

The product warranty is valid for one year after delivery and is limited to product repair or replacement for defects discovered and reported to us within that one year period. However, even if within the warranty period we accept absolutely no liability for any loss caused by natural disasters or improper product use. Copying or reprinting the contents described in this material in whole or in part is prohibited without our prior permission.

HAMAMATSU

www.hamamatsu.com

HAMAMATSU PHOTONICS K.K., Solid State Division

1126-1 Ichino-cho, Higashi-ku, Hamamatsu City, 435-8558 Japan, Telephone: (81)53-434-3311, Fax: (81)53-434-5184

U.S.A.: Hamamatsu Corporation: 360 Foothill Road, Bridgewater, N.J. 08807, U.S.A., Telephone: (1)908-231-0960, Fax: (1)908-231-1218, E-mail: usa@hamamatsu.com

Germany: Hamamatsu Photonics Deutschland GmbH: Arzbergerstr. 10, D-82211 Herrsching am Ammersee, Germany, Telephone: (49)8152-375-0, Fax: (49)8152-265-8, E-mail: info@hamamatsu.de

France: Hamamatsu Photonics France S.A.R.L.: 19, Rue du Saule Trapu, Parc du Moulin de Massy, 91882 Massy Cedex, France, Telephone: (33)1 69 53 71 00, Fax: (33)1 69 53 71 10, E-mail: infos@hamamatsu.fr

United Kingdom: Hamamatsu Photonics UK Limited: 2 Howard Court, 10 Tewin Road, Welwyn Garden City, Hertfordshire AL7 1BW, United Kingdom, Telephone: (44)1707-294888, Fax: (44)1707-325777, E-mail: info@hamamatsu.co.uk

North Europe: Hamamatsu Photonics Norden AB: Torshamnsgatan 35 16440 Kista, Sweden, Telephone: (46)8-509 031 00, Fax: (46)8-509 031 01, E-mail: info@hamamatsu.se

Italy: Hamamatsu Photonics Italia S.r.l.: Strada della Moia, 1 int. 6, 20020 Arese (Milano), Italy, Telephone: (39)02-93 58 17 33, Fax: (39)02-93 58 17 41, E-mail: info@hamamatsu.it

China: Hamamatsu Photonics (China) Co., Ltd.: B1201, Jiaming Center, No.27 Dongsanhuan Beilu, Chaoyang District, 100020 Beijing, P.R.China, Telephone: (86)10-6586-6006, Fax: (86)10-6586-2866, E-mail: hpc@hamamatsu.com.cn

Taiwan: Hamamatsu Photonics Taiwan Co., Ltd.: 8F-3, No. 158, Section2, Gongdao 5th Road, East District, Hsinchu, 300, Taiwan R.O.C. Telephone: (886)3-659-0080, Fax: (886)3-659-0081, E-mail: info@hamamatsu.com.tw