

ULTRA-FAST PHOTODETECTOR BIPLANAR PHOTOTUBES R12290U SERIES, R1328U SERIES

Biplanar phototubes are high-speed photodetectors capable of measuring waveforms of ultrashort optical pulses. Hamamatsu provides various types of biplanar photocathodes with different photocathodes to cover a wide range of applications spanning the vacuum UV to the infrared region.

■R12290U Series

The R12290U series have a large sensitive area and fast time response, such as 270 ps rise time and 100 ps fall time.

■R12290U-55 (For excimer laser measurements)

The R12290U-55 was developed to directly measure high energy light such as from excimer lasers. Compared to conventional thermal conversion type detectors and semiconductor sensors the R12290U-55 offers fast time response and stable operation even when measuring high energy light.

■R1328U Series

The R1328U series have very fast time response, such as 60 ps rise time and 90 ps fall time and excellent impedance matching. These characteristics make it possible to reproduce precise waveform of light pulses with extremely less ringing.



▲Left: R12290U
Right: R1328U

FEATURES

- Fast Time Response
- Excellent Linearity with Respect to High-power Light
- Conforms to RoHS Directive
- Easily Interfaceable with External Circuits
- Extremely Less Ringing
- High Immunity to Magnetic Fields

APPLICATIONS

- Laser Pulse Observation
- Trigger for Laser, Streak Camera, etc.
- Time Calibration in Subnanoseconds
- Trigger for Electronic Shutter, etc.

SPECIFICATIONS

Type No.	Spectral Response (nm)	Peak Wavelength (nm)	Photocathode Material	Anode Form	Maximum Ratings				Characteristics (at 25 °C)				
					Anode Supply Voltage (V dc)	Peak Cathode Current (A)	Input Light Energy Density (W/mm ²)	Average Cathode Current (μA)	Measuring Voltage (V dc)	Luminouse Typ. (μA/lm)	Peak Cathode Radiant Sensitivity (mA/W)	Rise Time Typ. (ps)	Fall Time Typ. (ps)

R12290U Series (Large sensitive area, 270 ps rise time)

R12290U-51	300 to 1100	750	Ag-O-Cs	Mesh	3000	1	0.125	50	2500	20	2.5	270	100
R12290U-52	185 to 650	340	Sb-Cs	Mesh	3000	1	0.125	50	2500	50	80	270	100
R12290U-53	300 to 850	400	Na-K-Sb-Cs	Mesh	3000	1	0.125	50	2500	80	50	270	100
R12290U-54	115 to 320	200	Cs-Te	Mesh	3000	1	0.125	50	2500	15 mA/W (254 nm)	25	270	100

R12290U-55 (For measurement of high-power pulsed light)

R12290U-55	180 to 350	220	Ag	Mesh	3000	2	1 × 10 ² (248 nm)	10	2500	15 μA/W (248 nm)	22 μA/W	270	130
------------	------------	-----	----	------	------	---	------------------------------	----	------	------------------	---------	-----	-----

R1328U Series (60 ps rise time)

R1328U-51	300 to 1100	750	Ag-O-Cs	Mesh	2500	0.3	0.125	5	2000	20	2.5	60	90
R1328U-52	185 to 650	340	Sb-Cs	Mesh	2500	0.3	0.125	5	2000	50	80	60	90
R1328U-53	300 to 850	400	Na-K-Sb-Cs	Mesh	2500	0.3	0.125	5	2000	80	50	60	90
R1328U-54	115 to 320	200	Cs-Te	Mesh	2500	0.3	0.125	5	2000	15 mA/W (254 nm)	25	60	90

NOTE: (A) Pulse width is less than 50 ns. (B) Output current averaged over 1 second time interval. The whole photocathode is uniformly illuminated. (C) Measured with a tungsten lamp operated at 2856 K and a 1 MΩ load resistor. The light input is 0.05 lm. (D) Rise time refers to the time rising from 10 % to 90 % of the peak photocathode current when delta function light pulse enters the whole photocathode. (E) Fall time refers to the time falling from 90 % to 10 % of the peak photocathode current when delta function light pulse enters the whole photocathode.

ULTRA-FAST PHOTODETECTOR

BIPLANAR PHOTOTUBES R12290U SERIES, R1328 SERIES

CONSTRUCTION

Biplanar phototubes consists of a circular, plane, lightsensitive surface called a photocathode and a mesh-type anode aligned in parallel to each other. Figure 1 shows the schematic construction of biplanar phototubes. The biplane configuration of the photocathode and anode make it possible to generate high linear output current with subnano-second response time.

As shown in Figure 1, a power supply capacitor C_b and a noninductive load resistor R_L are built into the housing.

Figure 1: Schematic Diagram

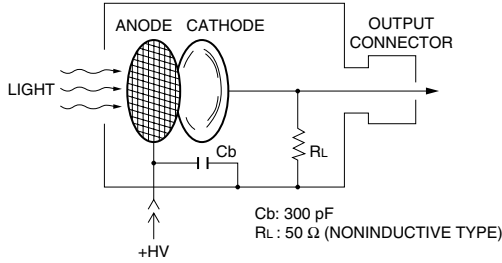

RESPONSE SPEED

If the interelectrode distance of a biplanar phototube is d [m], the applied voltage is E [V] and the electron transit time is τ [s], then the pulse response rise time (10% to 90%) t_r [s] is given by the following expression and is inversely proportional to the square root of the applied voltage E .

$$\tau = d \sqrt{\frac{2m}{qE}} = 3.37 \times 10^{-6} \times \frac{d}{\sqrt{E}} \text{ [s]}$$

$$t_r \approx 0.8\tau \text{ [s]}$$

Where m and q are the electron mass and charge respectively.

Figure 2: Typical Rise time

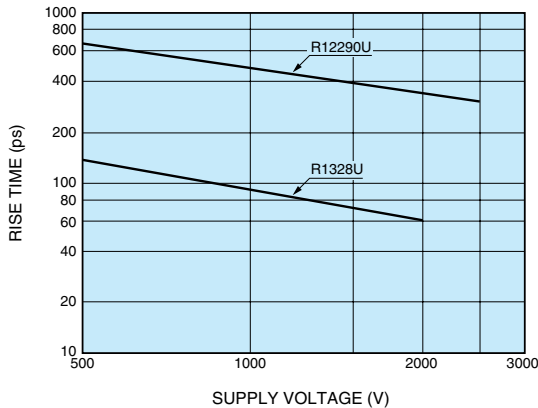

DARK CURRENT

Because biplanar phototubes are used at high voltages, the dark current for such devices is normally large compared to conventional phototubes, so dark current values similar to those of conventional phototubes used with lower voltages cannot be expected.

In addition to thermal electrons from the photocathode and ion current, dark currents are generated by leakage currents flowing through the insulation material used, which dominates a large portion of the total. This type of leakage currents flows even in moisture and other impurities on the surface of the insulation material. For this reason, it is recommended that not only care should be taken to the handling of such devices during measurements but also consideration should be taken to the storage of such devices in a desiccator.

SPECTRAL RESPONSE CHARACTERISTICS

Figure 3(a) shows typical spectral response characteristics of the R12290U and R1328U series.

Figure 3(a): Typical Spectral Response Characteristics of R12290U and R1328U

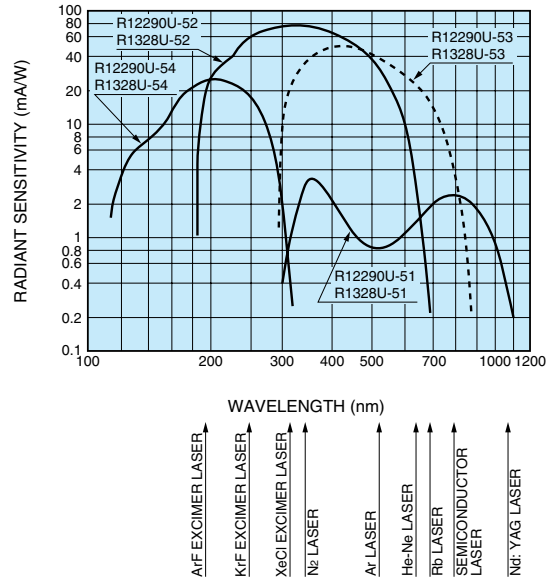
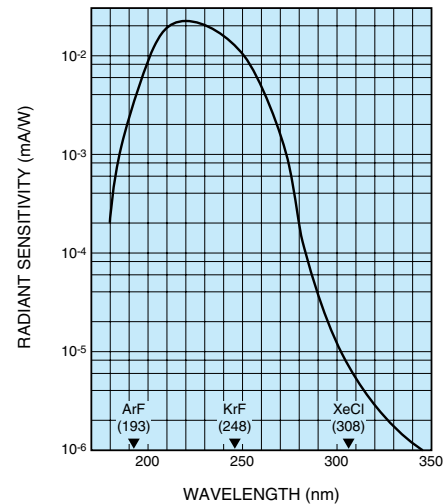

Figure 3(b): Typical Spectral Response Characteristics of R12290U-55



MAXIMUM OUTPUT CURRENT

Biplanar phototubes are used for an application in the observation of laser pulses using an oscilloscope and the triggering of various circuits. This requires a high input signal level of more than 50 mV. However, because it is difficult to conduct electrical amplification of a signal pulse width in the order 0.1 ns, an extremely high current linearity with respect to high-power light is required. For instance, when the peak photocathode current is 100 mA, a voltage of 2.5 V appears at the both ends of the resistance (25 Ω that the photocathode sees), the value of which is sufficient enough to drive the oscilloscope and its trigger circuit directly.

Since biplanar phototubes are constructed with two electrodes of large facing areas closely paralleled to each other and since they can withstand high voltages, they can fetch large currents. Factors which determine the maximum rating of the peak photocathode current are: 1) space charge, 2) photocathode surface saturation, 3) residual gas pressure and 4) photocathode surface fatigue, among others. In consideration of these factors, the Hamamatsu R12290U-51 to -54, R12290U-55 and R1328U series are designed to operate up to 1 A, 2 A and 0.3 A respectively when light pulses of 50 ns width are used.

MAXIMUM EXCIMER LASER MEASUREMENT RANGE OF R12290U-55

The R12290U-55 is designed for use in the measurement of excimer lasers that have high-power light pulses. Combined with an attenuation filter (E3331: sold separately) it is particularly suited for measurements of excimer lasers being directly illuminated onto the photocathode at very high power levels. (See figure 4.)

Maximum Excimer Laser Measurement Range

Items	No attenuation filter			Attenuation filter (sold separately)		
	ArF (193 nm)	KrF (248 nm)	XeCl (308 nm)	ArF (193 nm)	KrF (248 nm)	XeCl (308 nm)
Input Light Energy Density (W/mm ²)	1 × 10 ²	1 × 10 ²	4 × 10 ⁵	5 × 10 ⁴	5 × 10 ⁴	—
Peak power* (W)	7 × 10 ⁴	7 × 10 ⁴	1 × 10 ⁸	2.5 × 10 ⁷	2.5 × 10 ⁷	—

* Peak power (W) = $\frac{\text{Excimer laser pulse energy (J)}}{\text{FWHM of excimer laser pulse (s)}}$

Figure 4: Light Saturation (Linearity) Characteristics

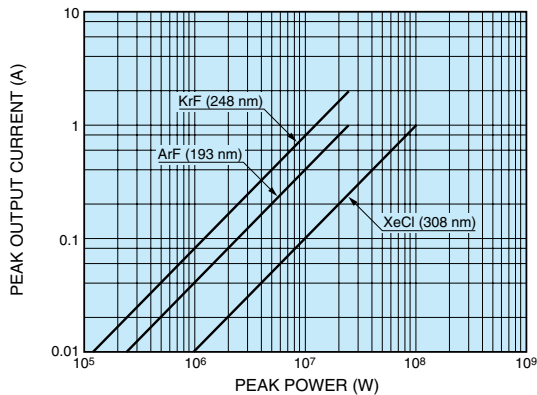

* The data of ArF and KrF excimer lasers are those obtained when an attenuation filter E3331 (sold separately) was used.

RINGING

The distortion of a high-speed pulse signal is greatly effected by the measurement system used to measure this signal. For instance, when impedance matching is taking place between the phototube and the measurement system, a portion of the signal may happen to become a reflection signal and return back to the phototube. A portion of this reflection signal is then once again propagated through the phototube to the oscilloscope. As a result a periodically diminishing signal or damping oscillation is observed on the oscilloscope. This phenomenon is known as ringing. (See Figure 5.)

Figure 5: Typical Pulse Distortion by Ringing

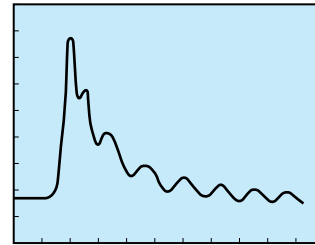

The R12290U and R1328U are built in a special metal housing designed with well considerations of electrode shape, housing shape, the widening of bandwidth and the impedance matching of a load resistance output connector. Their laser pulses are thus output through the N-R connector of an excellent frequency characteristic. For this reason, you must use their output cable, connector and characteristic impedance of the measuring system at 50 Ω.

■ DIMENSIONAL OUTLINE (Unit: mm)

● R12290U

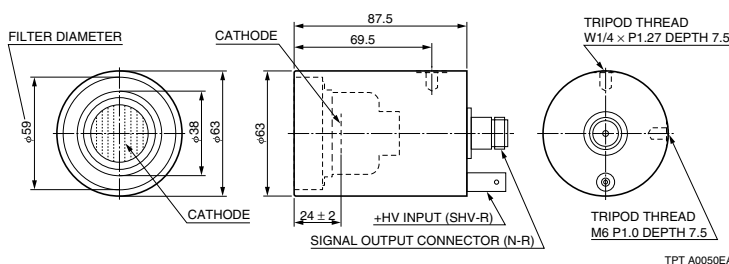

TPT A0050EA

● R1328U

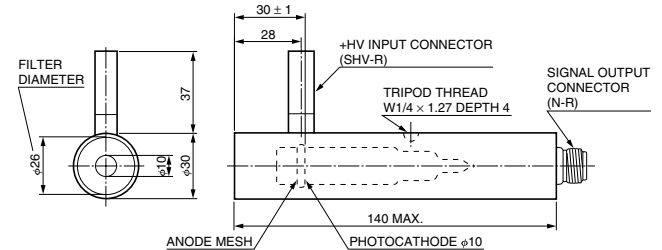

TPT A0018EB

● Diameter and Area of Photocathode

Type No.	Diameter (mm)	Area (mm ²)
R12290U-51 to -54	φ20	314
R12290U-55	φ29	660
R1328U Series	φ10	78

1. Since these devices use a high voltage from 2000 V to 2500 V, extreme care should be taken to ensure the safety of personnel handling and using these devices, especially with respect to insulation and shock prevention.
2. When preparing for measurement, be sure to short the signal output connector before connecting the signal cable with it in order to allow electric charge stored in the device to be discharged.
3. As an added measure for accident prevention, when a high voltage power supply with a low impedance output is used, a protective CR network can be placed between the power supply and the phototube as shown in figure 12. It is recommended that, if actually used, an CR network with the values or similar values shown in the figure be selected and placed as close to the phototube as possible.
4. If the phototube envelope is broken and air is allowed to enter the tube, the tube will become unusable. Therefore, care should be taken not to subject the tube to shock.
5. Use with high currents will tend to cause the phototube to fatigue, causing a deterioration of its characteristics. Therefore, unnecessarily high currents should not be used and care should be taken so that strong intensity beams are not shone on one portion of the photocathode. In particular, if such a condition exists, it is recommended that a diffuser plate be used.
6. Care should be taken to avoid high humidity. When storing the devices they should be packed together with a desiccant or contained in a desiccator.

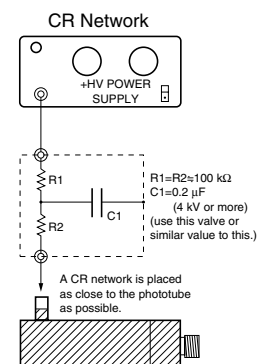

DANGER ... Do NOT apply a high voltage unless insulation is sufficiently provided.

ULTRA-FAST PHOTODETECTOR BIPLANAR PHOTOTUBES R12290U SERIES, R1328U SERIES

OPTIONAL ACCESSORIES

Some optional devices, such as high voltage power supply, cable set and attenuation filter, need to be purchased for the use of phototubes. Hamamatsu has all those optional devices available to you.

HIGH VOLTAGE POWER SUPPLY C11668 (Sold separately)

Specifications

Output voltage Changed to +1.5 kV dc
+2.0 kV dc · +2.5 kV dc
Output current 0.3 mA Max.
Output voltage change Less than $\pm 1\%$ with respect to
10 % change of supply voltage
Less than $\pm 1\%$ with respect to 0
to 100 % change of output current
Ripple noise (peak to peak) 1 V Max.
Output terminal SHV connector (Rear Side)
Supply voltage 12 Vdc (Supplied: AC adapter 100 V to 240 V)
Operating ambient temperature ... +5 °C to +45 °C
Weight Approx. 1130 g

Dimensional Outline (Unit: mm)

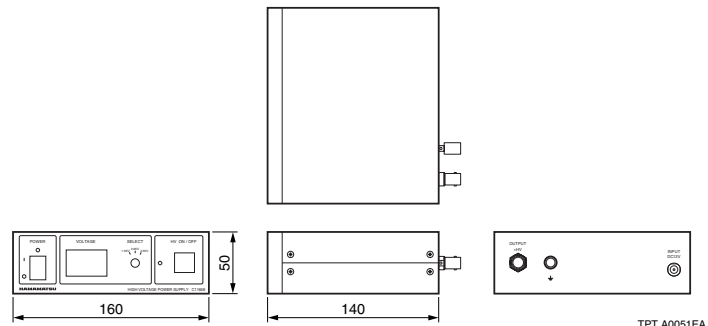

SIGNAL CABLES E1168-01, -02 (Sold separately)

Signal cables used to connect the signal output of the phototube to the oscilloscope.

Two types of connectors, such as N-N type connector and N-BNC connector, are available for E1168-01 and E1168-02 respectively. (A coaxial cable of characteristic impedance 50 Ω should be used.)

Typical System Configurations

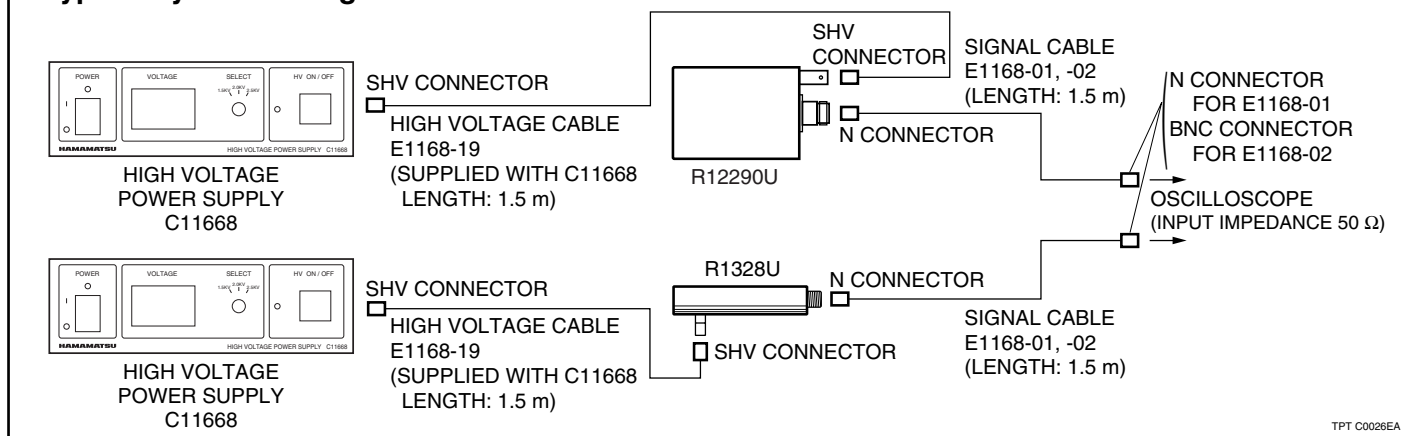

ATTENUATION FILTER E3331 FOR R12290U (Sold separately)

The E3331 is designed with an easy-to-mount feature and for exclusive use with R12290U series. It is able to accept direct, high-power light.

* The filter transmits above 180 nm.

Transmittance=0.2 % (Typ.)

Dimensional Outline (Unit: mm)

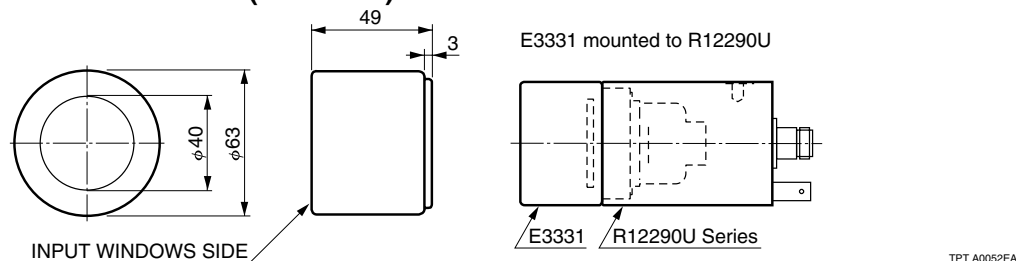

HAMAMATSU PHOTONICS K.K. www.hamamatsu.com

HAMAMATSU PHOTONICS K.K., Electron Tube Division

314-5, Shimokanzo, Iwata City, Shizuoka Pref., 438-0193, Japan, Telephone: (81)539/62-5248, Fax: (81)539/62-2205

U.S.A.: Hamamatsu Corporation, 360 Foothill Road, P. O. Box 6910, Bridgewater, N.J. 08807-0910, U.S.A., Telephone: (1)908-231-0960, Fax: (1)908-231-1218 E-mail: usa@hamamatsu.com

Germany: Hamamatsu Photonics Deutschland GmbH: Arzbergerstr. 10, D-82211 Herrsching am Ammersee, Germany, Telephone: (49)8152-375-0, Fax: (49)8152-2658 E-mail: info@hamamatsu.de

France: Hamamatsu Photonics France S.A.R.L.: 19, Rue du Saule Trapu, Parc du Moulin de Massy, 91882 Massy Cedex, France, Telephone: (33)1 69 53 71 00, Fax: (33)1 69 53 71 10 E-mail: infos@hamamatsu.fr

United Kingdom: Hamamatsu Photonics UK Limited: 2 Howard Court, 10 Tewin Road Welwyn Garden City Hertfordshire AL7 1BW, United Kingdom, Telephone: 44-(0)1707-294888, Fax: 44-(0)1707-325777 E-mail: info@hamamatsu.co.uk

North Europe: Hamamatsu Photonics Norden AB: Thorshamnsgatan 35 SE-164 40 Kista, Sweden, Telephone: (46)8-509-031-00, Fax: (46)8-509-031-01 E-mail: info@hamamatsu.se

Italy: Hamamatsu Photonics Italia: S.R.L.: Strada della Moia, 1/E, 20020 Arese, (Milano), Italy, Telephone: (39)02-935 81 733, Fax: (39)02-935 81 741 E-mail: info@hamamatsu.it

China: Hamamatsu Photonics (China) Co., Ltd.: 1201 Tower B, Jianning Center, 27 Dongsanhuan Road North, Chaoyang District, Beijing 100020, China, Telephone: (86)10-6586-6006, Fax: (86)10-6586-2866 E-mail: hpc@hamamatsu.com.cn

TPT 1028E01

OCT. 2012 IP