

# Product Document



## User Guide

UG000306

# Dragster Evaluation Kit

## User Guide Manual

EVALBOARD\_DRAGSTER

v2-00 • 2020-Jul-08

---

# Content Guide

<b>1</b>	<b>Introduction.....</b>	<b>3</b>	<b>4</b>	<b>Software Description.....</b>	<b>18</b>
1.1	Kit Content.....	3	4.1	Getting Started.....	18
1.2	Ordering Information .....	4	4.2	GUI Description.....	18
<b>2</b>	<b>Getting Started.....</b>	<b>5</b>	<b>5</b>	<b>Live Image.....</b>	<b>22</b>
<b>3</b>	<b>Hardware Description.....</b>	<b>7</b>	<b>6</b>	<b>Dragster Evaluation Mode .....</b>	<b>23</b>
3.1	Hardware Architecture .....	7	6.1	Sensor Reading Speed.....	23
3.2	Evaluation Board Components and Connectors Pinout.....	8	<b>7</b>	<b>Table of Abbreviations.....</b>	<b>26</b>
3.3	Power Supply .....	10	<b>8</b>	<b>Revision Information.....</b>	<b>27</b>
3.4	Board Reset .....	10	<b>9</b>	<b>Legal Information .....</b>	<b>28</b>
3.5	Assembling Dragster Sensors on the Evaluation Board .....	11			
3.6	Camera-Link Data Interface .....	15			
3.7	Serial Configuration Interface.....	17			

---

# 1 Introduction

---

The evaluation system enables an easy setup of Dragster line scan family for a quick sensor evaluation.

The system's FPGA provides the control signals to the sensor, defining the state machine timings. The user can choose one sensor clock out of two possibilities: 20 MHz and 80 MHz. The FPGA acquires data synchronously and multiplexes the same to the camera link base configuration connector. Any grabber that supports at least a camera link base configuration can directly retrieve the data from any Dragster sensor variation.

Over an RS232, serial interface, the user can configure the line rate and exposure time. Also, it can access to all sensor registers, performing write and read operations over SPI interface.

For debugging purposes, some digital IO sensor control signals are routed as CMOS TTL signals to the parallel connectors.

The evaluation of Dragster sensors uses a stack of three boards:

- Sensor headboard – Contains the Dragster sensor and connects to the FPGA board.
- Evaluation board – Versatile and easy to program, this board includes a SPARTAN 3AN FPGA, a micro controller for RS232 communication and 2 camera link full interfaces. It is the main board where the sensor headboard is connected.
- Power supply board – Under the main board there is a power supply board to create a group of filtered voltages to apply to the sensor, micro controller and RS232 sensor operation and Camera-Link.

By default, we have an FPGA code that reads out all sensors over one camera link, base connector, capable of operating the sensor with maximal line rate however discarding lines if the data rate coming from the sensor exceeds the data rate that can be transmitted over one base camera link connection.

---

## 1.1 Kit Content

The kit contains:

- Power supply (12 V, DC)
- USB to RS232 cable
- Sensor headboard
- Evaluation board
- Power supply board
- Evalboard FPGA interface board

The customer needs to acquire the frame grabber and the camera link cable.

Using our reference VHDL code, only one Camera-Link cable is required.

---

## 1.2 Ordering Information

Ordering Code	Description
EVALBOARD_DRAGSTER	Dragster Evaluation Kit

---

## 2 Getting Started

Add the following items to get started:

- Frame Grabber (on our side we use microEnable IV AD1-CL or VD1-CL from Silicon Software)
- 1x Camera-Link Cable



### Attention

Make sure the power supply is not yet connected before booting.

Make sure the power supply board is disconnected when connecting or disconnecting any other hardware.

Figure 1:  
Set Up Overview

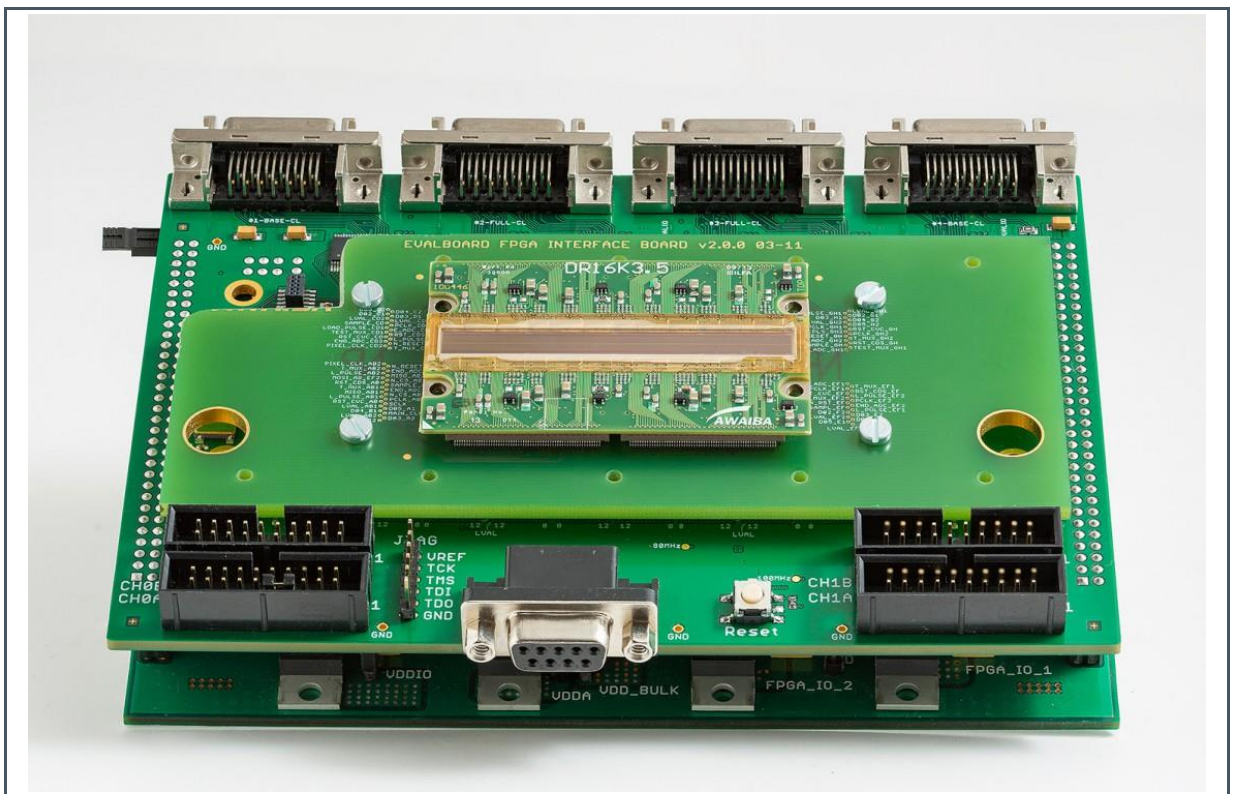

On device manager check if camera link cable and USB to serial port cable are correctly recognized, as exemplified in the below figure.



Figure 2:  
Cables Connection to PC

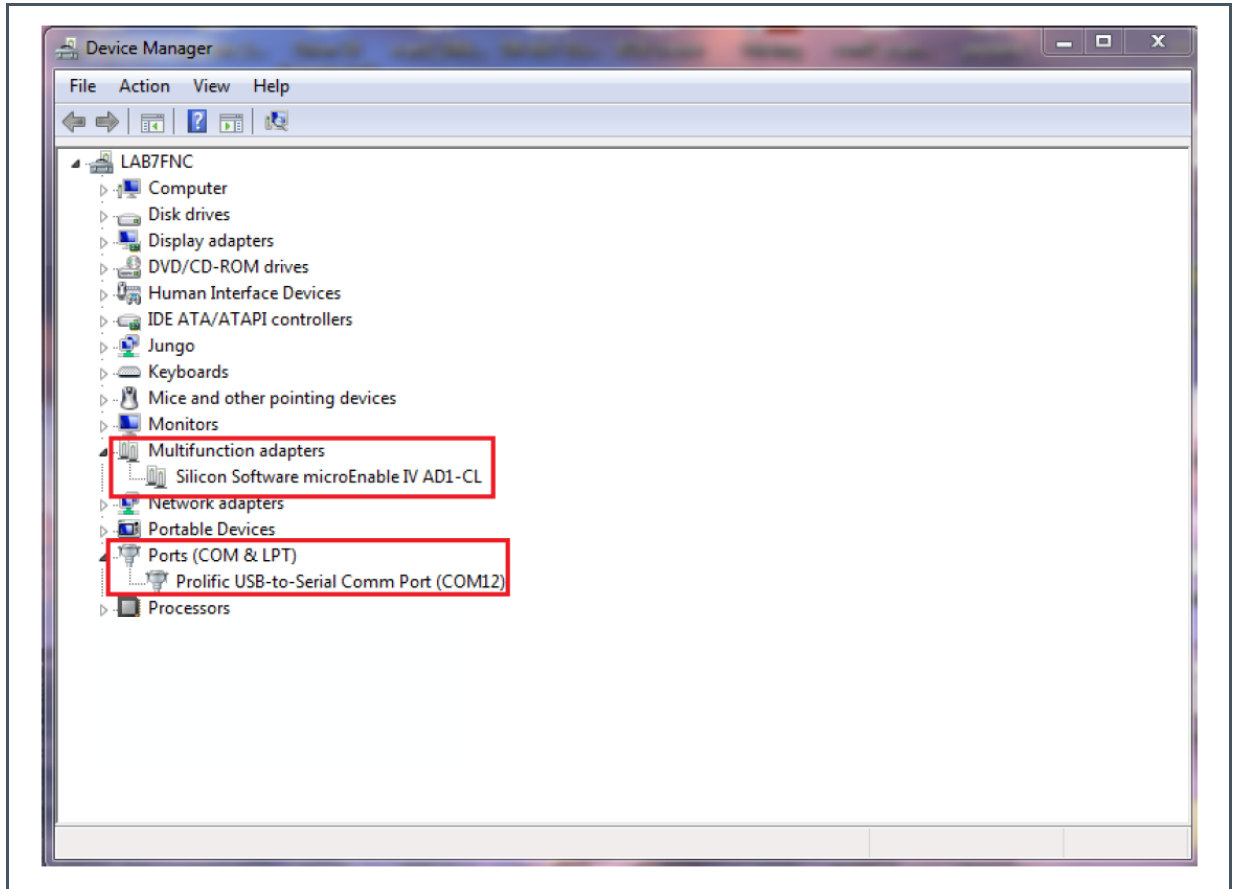

### 3 Hardware Description

This chapter describes the process of setting up the hardware.

#### 3.1 Hardware Architecture

The interface connections between the different components of the evaluation board is exemplified in the below figure.

**Figure 3:**  
Dragster Evaluation Board Block Diagram

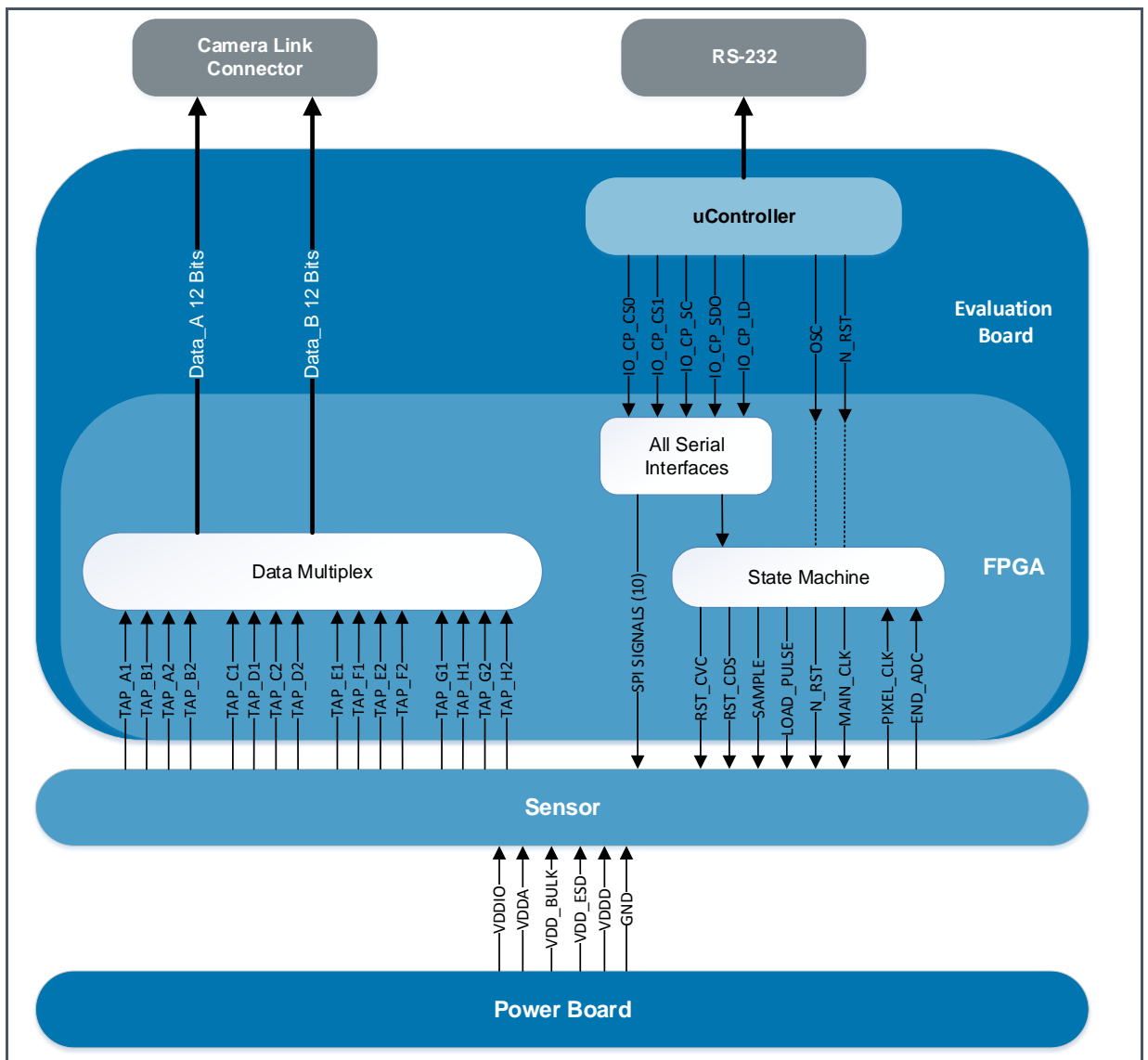



### 3.2 Evaluation Board Components and Connectors Pinout

Figure 4:  
Main Board Components

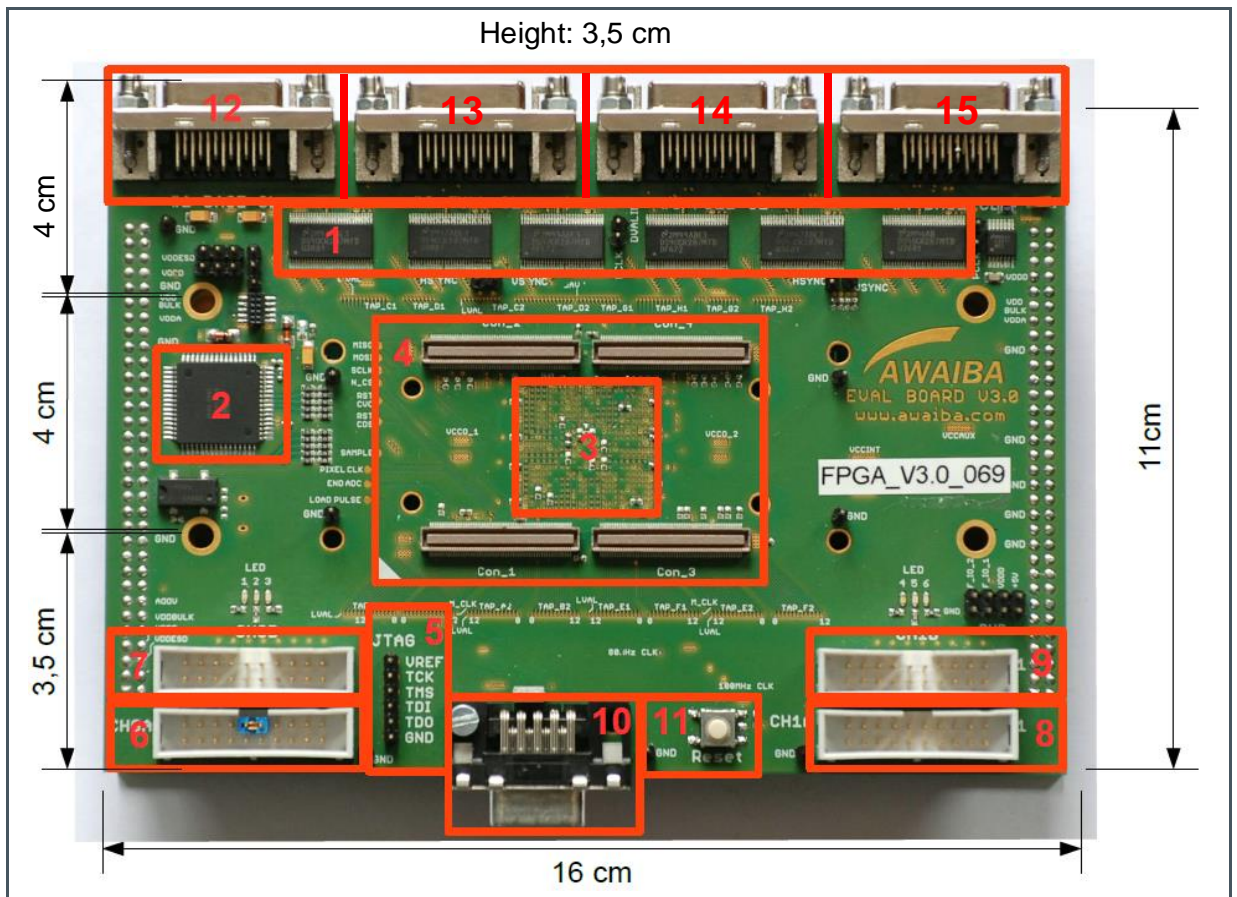

- |   |                                   |    |                                   |
|---|-----------------------------------|----|-----------------------------------|
| 1 | Camera-Link drivers               | 9  | Parallel TTL connector channel 1B |
| 2 | ATMega 128 controller             | 10 | Serial communication connector    |
| 3 | Spartan 3AN FPGA (bottom side)    | 11 | Board reset button                |
| 4 | Sensor connectors                 | 12 | Camera-Link base connector        |
| 5 | JTAG connector                    | 13 | Camera-Link full connector        |
| 6 | Parallel TTL connector channel 0A | 14 | Camera-Link full connector        |
| 7 | Parallel TTL connector channel 0B | 15 | Camera-Link base connector        |
| 8 | Parallel TTL connector channel 1A |    |                                   |

**Figure 5:**  
TTL Connectors Debug Signals

TTL Connector	S-Connectors Channel	Signal Name
CH0A	S00	80 MHz clock
	S02	Sensor clock
	S03	Camera link drivers clock
	S04	VCC
CH0B	S10	Sensor SCLK
	S11	Sensor MOSI
	S16	Test mode jumper
	S17	VDD
CH1A	S18	End ADC AB1
	S19	LVAL AB1
	S20	Sensor load pulse
	S21	Sensor sample
	S22	Sensor RST CVC
	S23	Sensor RST CDS
CH1B	S30	Pixel CLK AB1

**Figure 6:**  
S-Connectors Identification

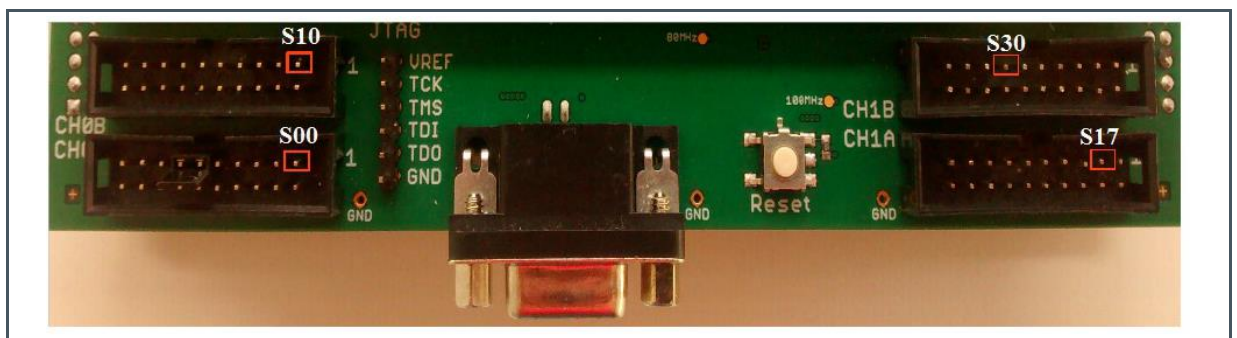

**Attention**

To ensure the correct operation of the system please do not remove jumper from S05 and S06!

### 3.3 Power Supply

The system main input voltage is 12 V DC. A green LED in the power board will turn on when the power is connected. It has also a 1A soldered fuse for user safety and board protection. After any wrong manipulation check its connectivity and if the LED does not start, please replace the fuse by another with same specification.

All voltages are generated in this board.

**Figure 7:**  
**Power Supply Connection**

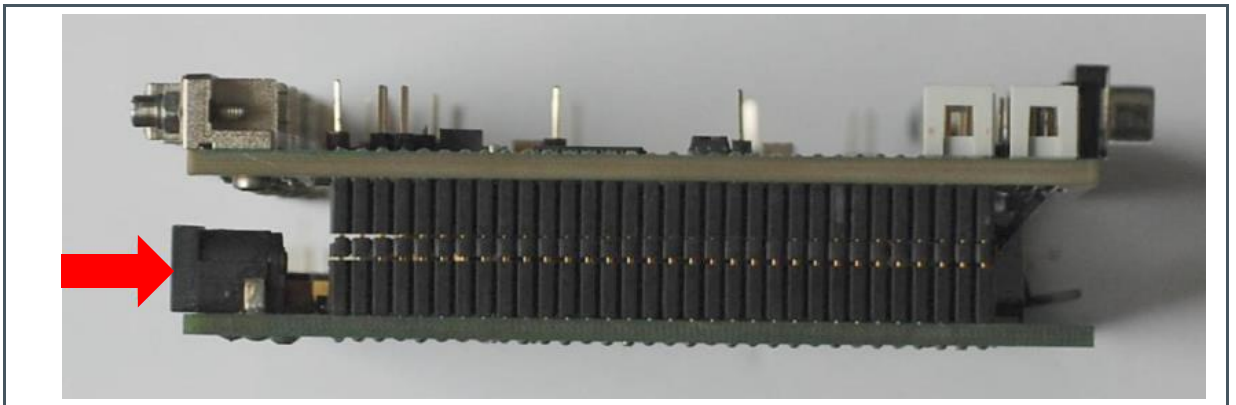

### 3.4 Board Reset

It is a good practice to perform a full system reset before starting evaluating the sensor. In the evaluation board, there are two possibilities to make this reset: by pressing the reset button or by sending the reset command. Both have the same effect of restarting the state machine's operation. After this, the sensor is loaded with the default values defined in the datasheet, which may obviously need to be reconfigured to match the current setup.



#### CAUTION

Always perform a reset to the system after power up to guarantee a defined power up status!

If the board does not start operation after power up, if the sensor was wrongly configured or if data is not consistent, please press the board reset button and reconfigure the sensor.

### 3.5 Assembling Dragster Sensors on the Evaluation Board

#### 3.5.1 Assembling DR4K7um on the Evaluation Board

Dragster 4K7um sensor is assembled in connector 1 of the evaluation board, with the triangle marks aligned.

Figure 8:  
Assembling DR4K7um on the Evaluation Board

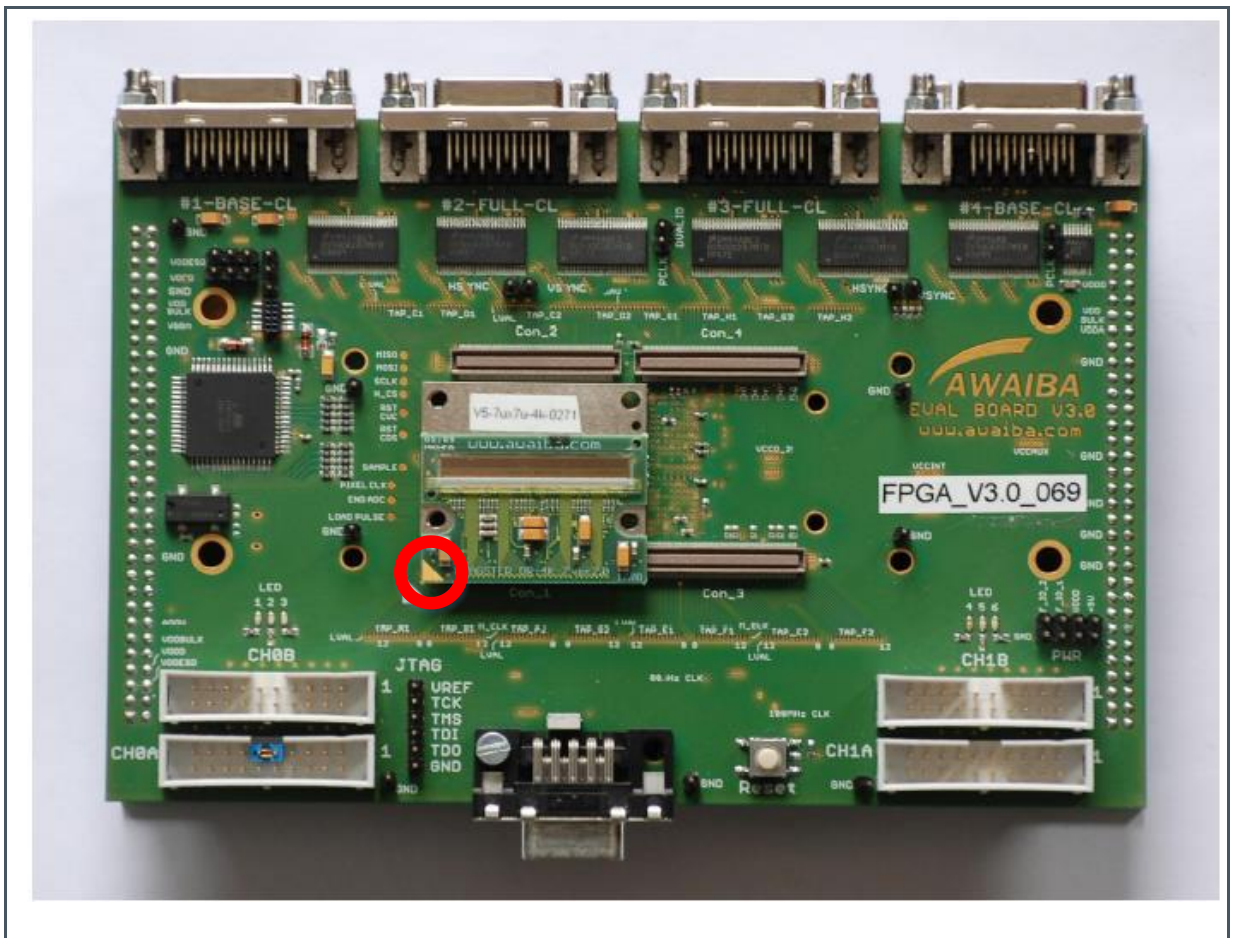

**Attention**

Please note that the above image is only for demonstration purposes. To ensure the correct operation of the system it is recommended not to remove the Evalboard FPGA interface board (red PCB). Furthermore, please note that with the red PCB the sensor triangle is oriented to the serial communication connector.



### 3.5.2 Assembling DR8K7um on the Evaluation Board

Dragster 8K7um sensor is assembled in the bottom side connectors (connector 1 and connector 3) of the evaluation board, with the triangle marks aligned.

Figure 9:  
Assembling DR8K7 on the Evaluation Board

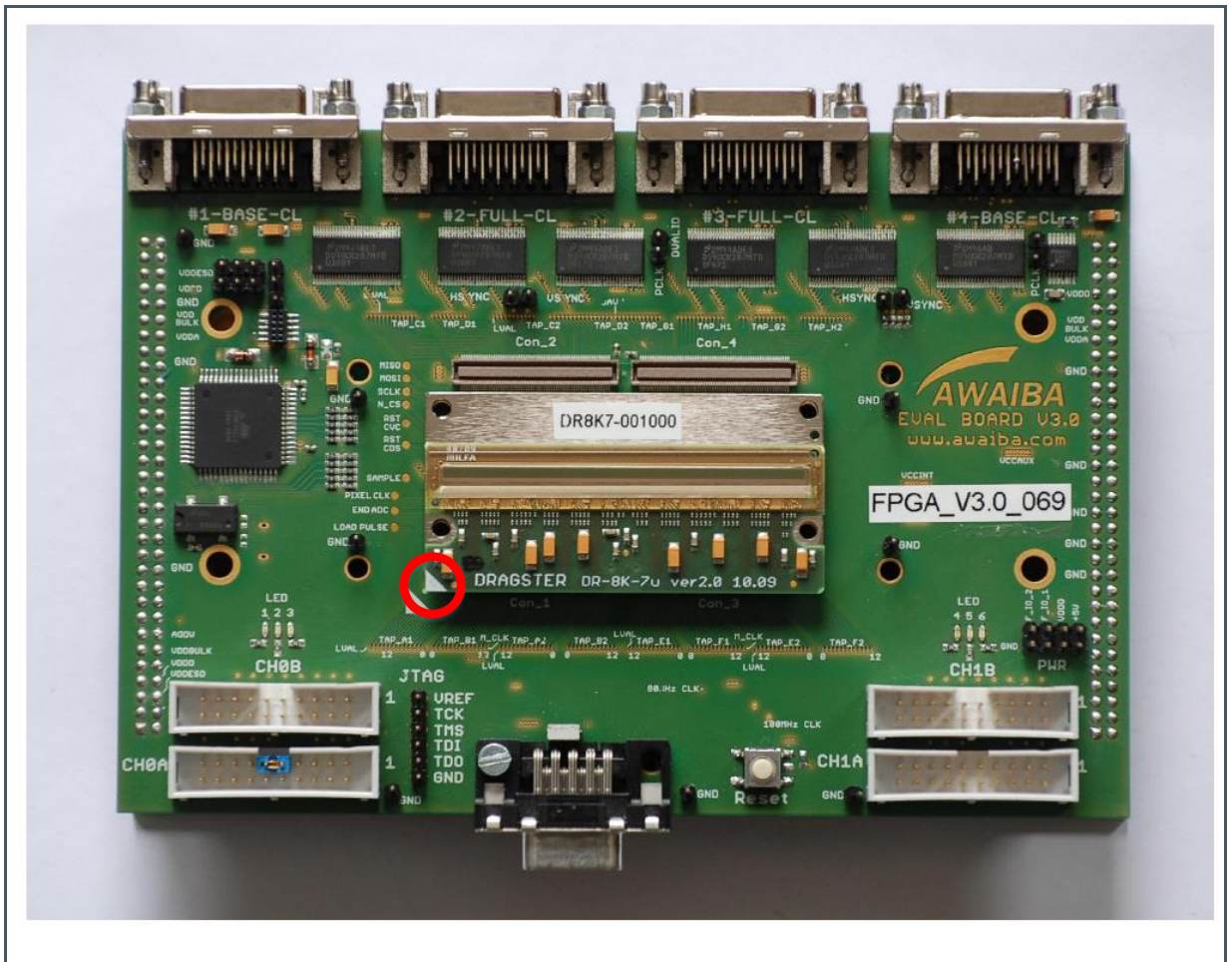

**Attention**

Please note that the above image is only for demonstration purposes. To ensure the correct operation of the system it is recommended not to remove the Evalboard FPGA interface board (red PCB). Furthermore, please note that with the red PCB the sensor triangle is oriented to the serial communication connector.

### 3.5.3 Assembling DR8K3.5um on the Evaluation Board

Dragster 8K3.5um sensor is assembled in connectors 1 and connector 2 of the evaluation board, with the triangle marks aligned.

Figure 10:  
Assembling DR8K3.5 on the Evaluation Board

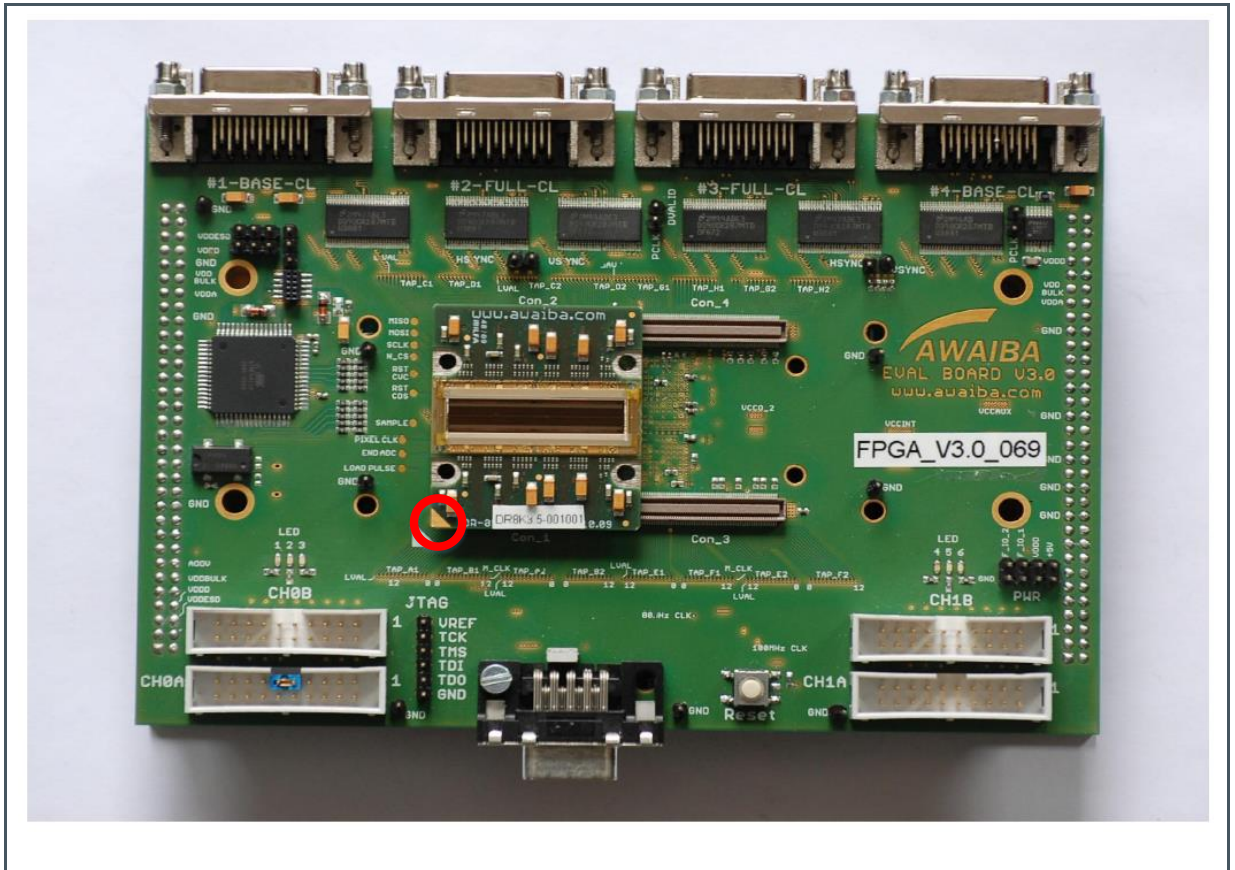

#### Attention

Please note that the above image is only for demonstration purposes. To ensure the correct operation of the system it is recommended not to remove the Evalboard FPGA interface board (red PCB). Furthermore, please note that with the red PCB the sensor triangle is oriented to the serial communication connector.

### 3.5.4 Assembling DR16K3.5um on the Evaluation Board

Dragster 16K3.5um sensor is assembled in the four connectors of the evaluation board. The sensor orientation is such that the triangle marker on the sensor headboard aligns with the white triangle on the evaluation board.



Figure 11:  
Assembling DR16K3.5um on the Evaluation Board

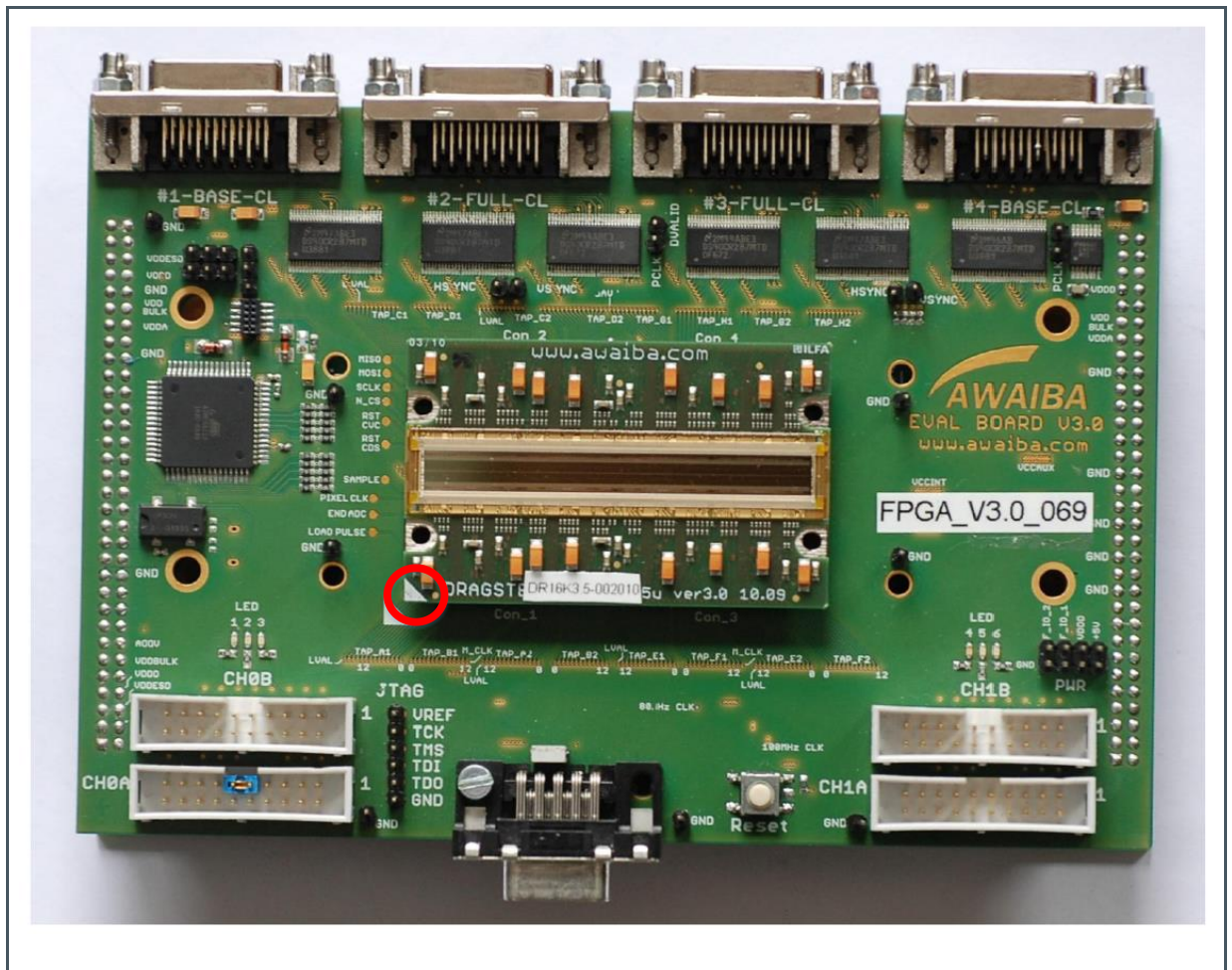

**Attention**

Please note that the above image is only for demonstration purposes. To ensure the correct operation of the system it is recommended not to remove the Evalboard FPGA interface board (red PCB). Furthermore, please note that with the red PCB the sensor triangle is oriented to the serial communication connector.



### 3.6 Camera-Link Data Interface

#### 3.6.1 Tap Assignment DR16K3.5um

The FPGA board can receive up to 16TAPS of 12 bits each so that it reads out all DR16K3.5um sensor. The data received in the FPGA are multiplexed and sent to one Camera-Link connector through Data\_A and Data\_B.

**Figure 12:**  
Camera-Link Output DR16K3.5um

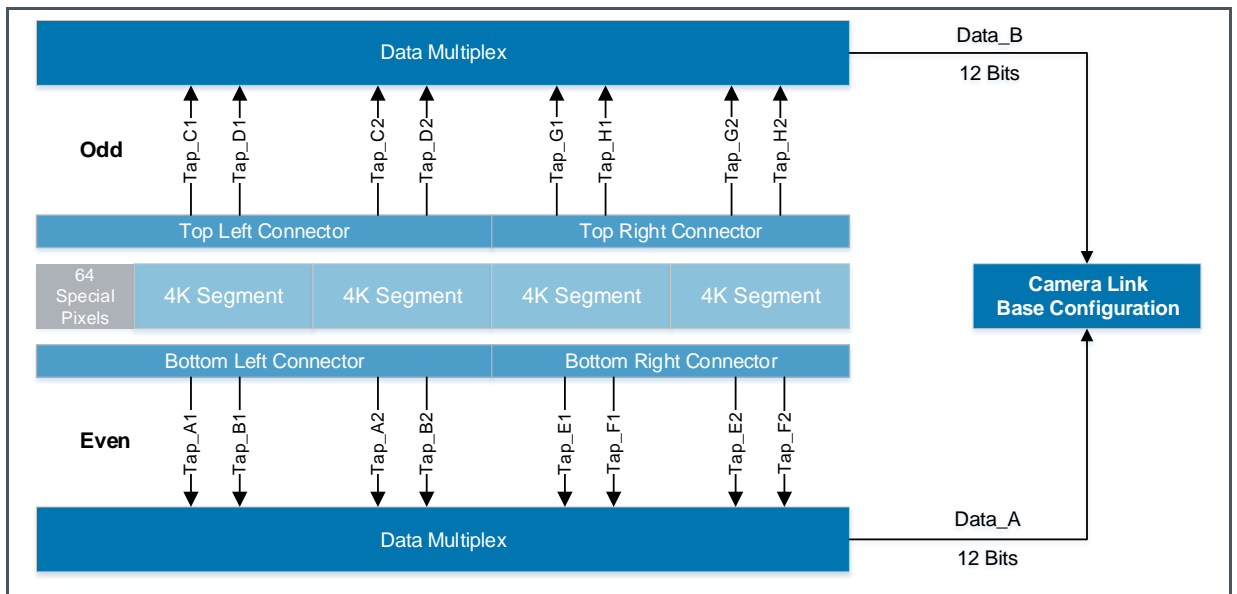

The explanation above is valid for DR16K3.5um sensor. The FPGA implementation is compatible with all sensor variations that means that in case other sensors are tested, like DR4K or DR8K, not all the TAPs will contain valid data.



**Attention**

Make sure that the Camera-Link drivers are enabled when trying to capture image data!

### 3.6.2 Tap Assignment DR8K7um

Figure 13:  
Camera-Link Output DR8K7um

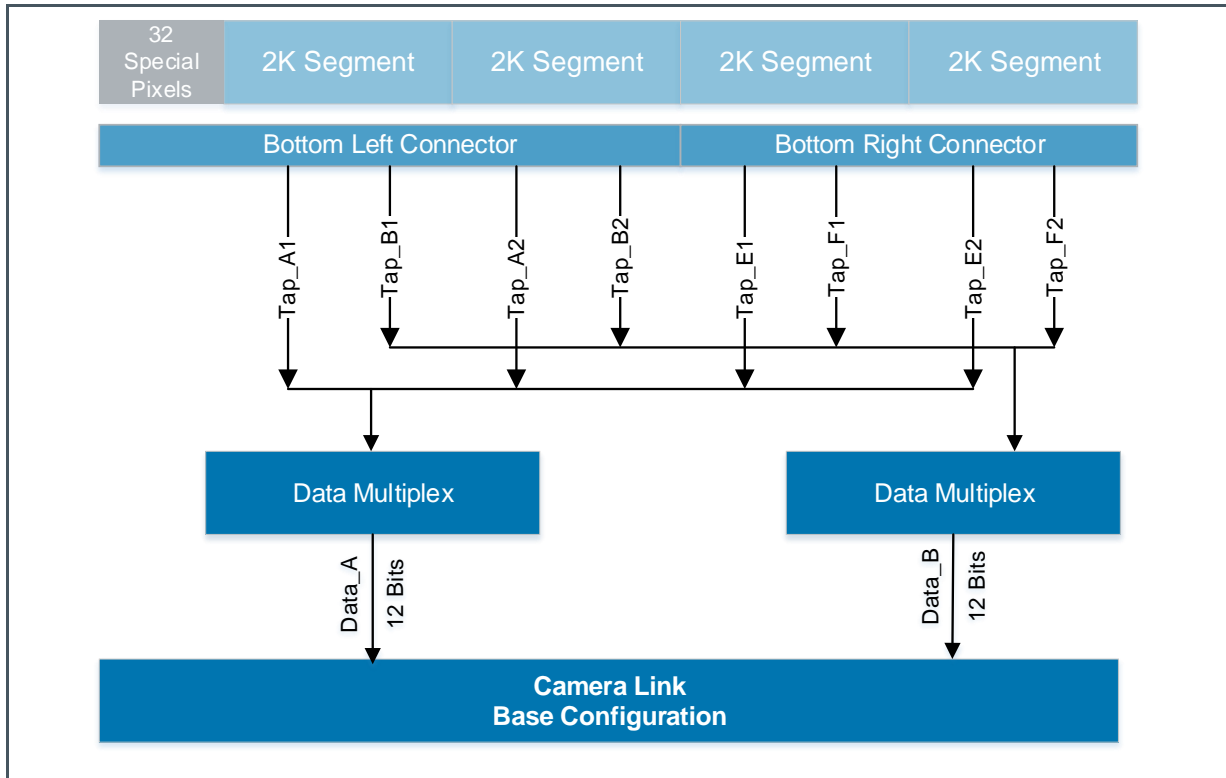

### 3.6.3 Tap Assignment DR2X8K7um

Figure 14:  
Camera-Link Output DR2X8K7um

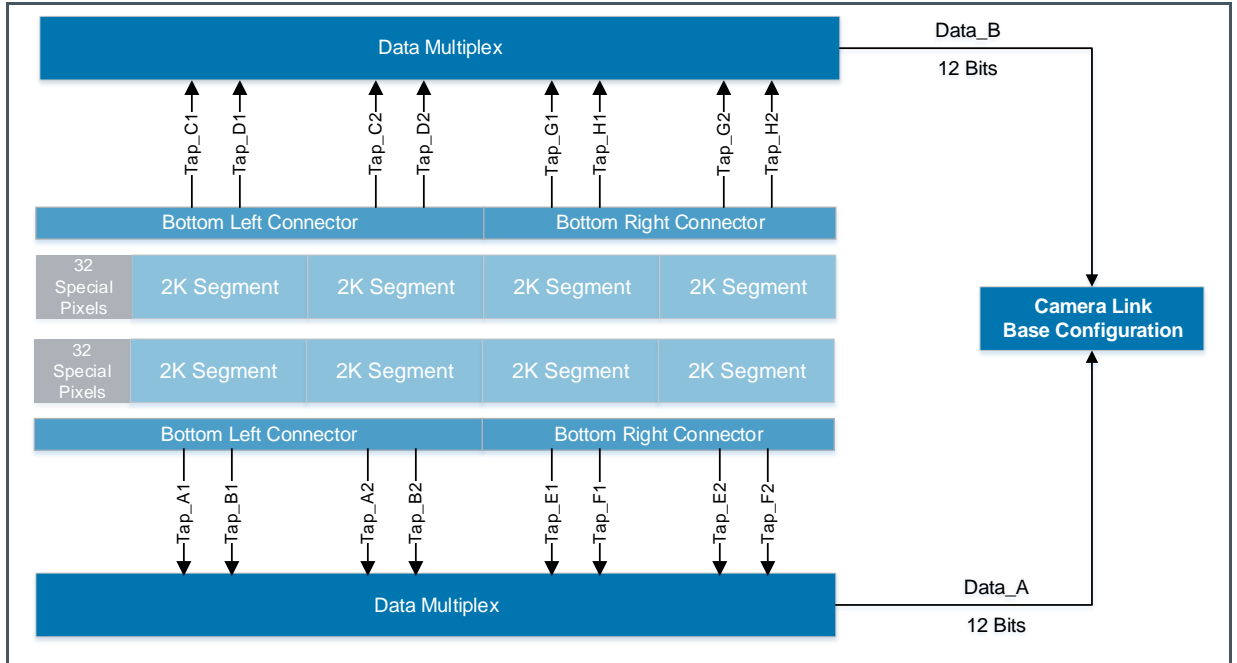

## 3.7 Serial Configuration Interface

The state machine's basic parameters, like line and integration time, together with all sensor's registers are accessible via a RS232 interface.

The serial communication uses a USB communication port on the PC side and a D-SUB 13 connector on the board's side. Please note that serial communication over Camera-Link is not implemented.

### 3.7.1 Serial Port Configuration

The serial port communication is automatically set to the following parameters:

- Baud Rate: 19200
- Data Bits: 8
- Stop Bits: 1
- Parity: None
- Flow Control: None

## 4 Software Description

DragsterComm is a software that allows the user to change the register settings of Dragster's family sensors using a RS232 communication port.

DragsterComm runs only under Windows OS.

The latest DragsterComm software package is available at **ams** webpage ([www.ams.com/dragster#tab/tools](http://www.ams.com/dragster#tab/tools)) to download.

### 4.1 Getting Started

When starting the DragsterComm a configuration window is automatically opened.

**Figure 15:**  
Configuration Window at Application Start

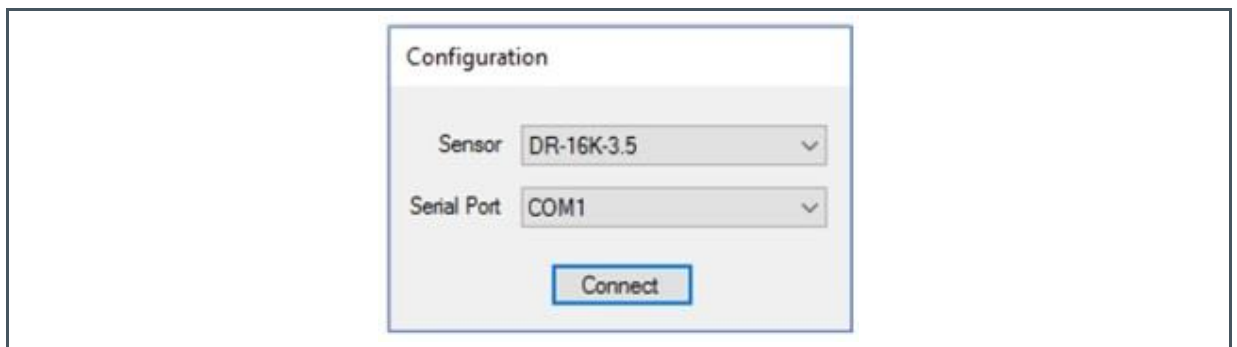

The configuration window allows the user to choose the sensor to evaluate which will be loaded with the default registers.

Normally, the serial port is chosen automatically. Nevertheless, please confirm that the chosen port is the correct one.

After setting, the sensor and the serial port please use "Send All" button in order to configure the default registers to the sensor.

### 4.2 GUI Description

The interface main features is listed in the below figure.

Please note that some limits of the sensor register were implemented to avoid configuration error.

Figure 16:  
DragsterComm Interface Features

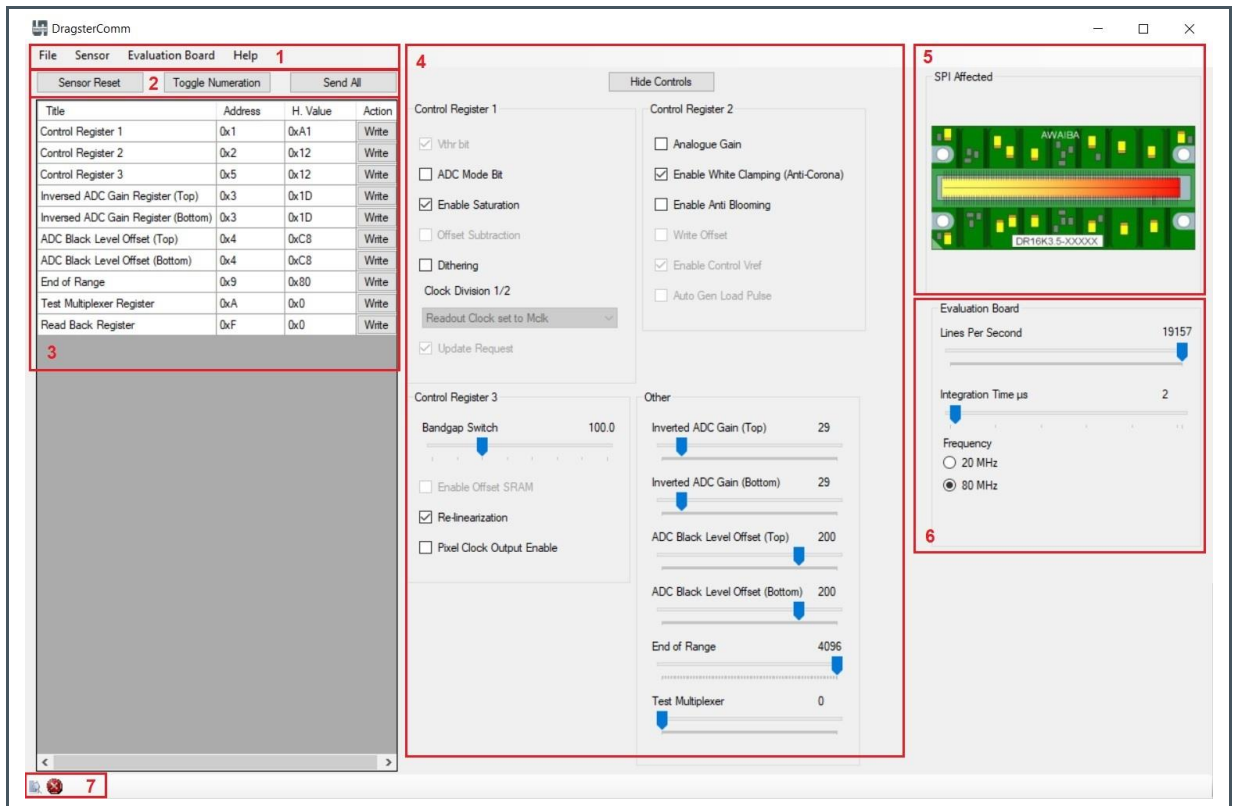

- 1 Menu bar
- 2 Sensor registers controls
- 3 Sensor registers
- 4 Sensor register's bit values
- 5 SPI affected
- 6 Evaluation board
- 7 Status bar

### 4.2.1 Menu Bar

In the menu bar the following options are available:

- File
  - Save configuration
  - Load configuration
  - Exit
- Sensor
  - Change sensor
  - Reset sensor
- Evaluation board
  - Configure serial port

- Help
  - About DragsterComm

## 4.2.2 Sensor Registers Controls

The buttons functions are:

- Sensor Reset: Sends the default register values
- Toggle Numeration: Change the registers values from hexadecimal to decimal
- Send All: Writes all registers values at once to the sensor

## 4.2.3 Sensor Registers

This table contains the registers name, address, value and operation. These register values can be changed or updated by using the sensor register bit values in feature 4.

In case the input value is not allowed because it exceeds the register's maximum or minimum value or because a wrong character was inserted, a red highlight will appear.

## 4.2.4 Sensor Register's Bit Values

This feature allows the user to change the register's bit values.

The slider option is limited to the sensor maximum and minimum values.

For more information regarding the sensors registers operation please refer to Dragster datasheet.

## 4.2.5 SPI Affected

The register values are, by default, sent to all SPI's at a time. In case of a fine tune of the sensor, to compensate deviations in gain and black level references along different segments, a different SPI can be chosen (top or bottom), and programmed.

This feature displays which SPI is affected with the change in registers.

## 4.2.6 Evaluation Board

With this feature, the user can control the lines per second, the integration time and the frequency of the main clock (20 MHz and 80 MHz).

Please note that the frequency will affect the lines per second limits, which affects the integration time, maximum value. In addition, also the ADC End of Range register affects the lines per second. For more information, please refer to chapter 6.

## 4.2.7 Status Bar

### Log Window

It is possible to see all the history of the commands since DragsterComm was started, and export it to a .txt file. Furthermore, the history of the current and previous sessions can be cleaned. A Log window is exemplified in the below figure.

Figure 17:  
Log Window

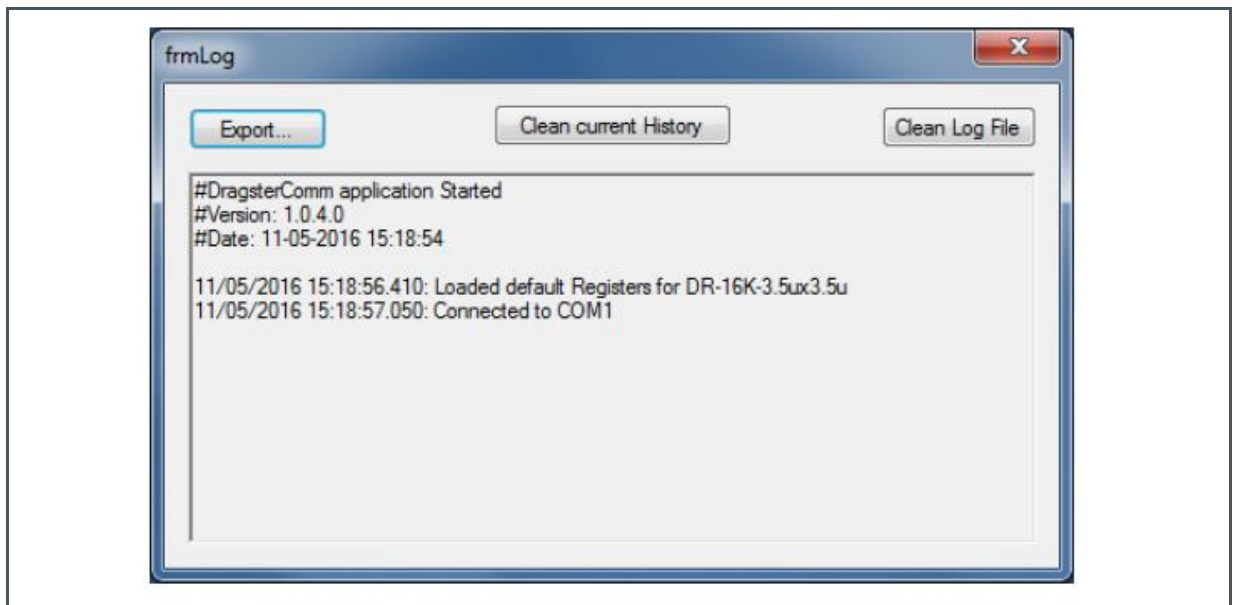

### Status Icon

Figure 18:  
Status Icon Identification

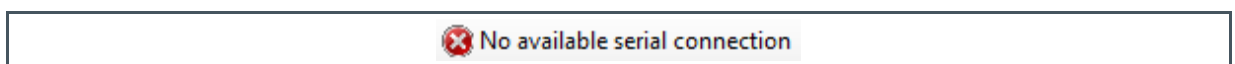



# 5 Live Image

An image from the sensor can be displayed using microDisplay software from Silicon Software as exemplified in the below figure.

**Figure 19:**  
**Sensor Live Image on microDisplay Software**

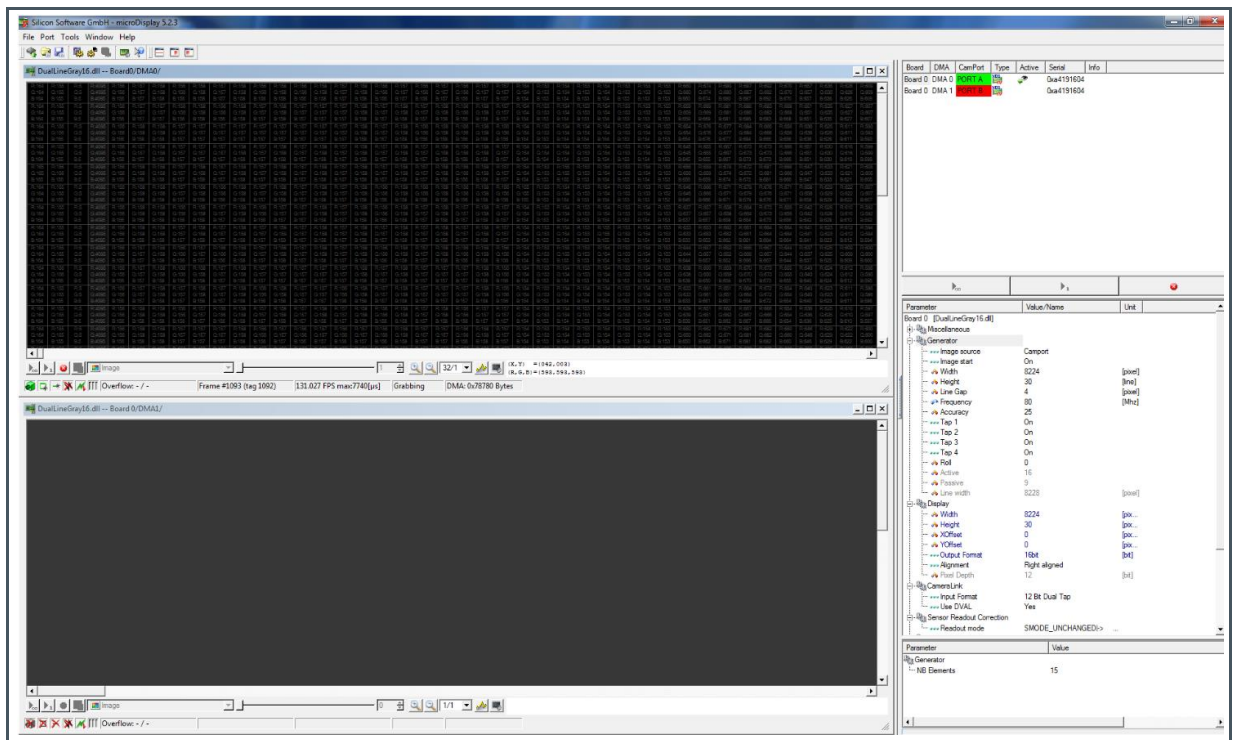

For each sensor, the resolution (width) and height needs to be set in Generator and Display section.

The Camera Link has to be configured to 12 Bit Dual TAP input format.

In Sensor Readout Connection, the readout mode has to be set to SMODE\_UNCHANGED for single line sensor and SMODE\_TAB2\_0 for dual line.

## 6 Dragster Evaluation Mode

### 6.1 Sensor Reading Speed

For the correct operation of Dragster it is recommended that the line period must be longer than the maximum of:

- ADC time
- Integration time + 2  $\mu$ s
- LVAL period

#### 6.1.1 Linear Mode

The ADC End of Range register can be adjusted between 0 and 127DN. By setting this value and the frequency of the main clock, we automatically get the ADC Time.

**Equation 1:**

$$ADC\ Time = \left( \frac{32 \times [Register\ 0x09]}{Main\ Clock} \right) + 1\ \mu s$$

The LVAL period is 1052 clocks. With this we can get the time that the sensor takes to make a readout.

**Equation 2:**

$$Readout\ Time = \frac{1052}{Main\ Clock}$$

The maximum value between ADC time and readout time gives the Minimum Line Period ( $\mu$ s).

The FPS value is calculated through the following formula.

**Equation 3:**

$$FPS = \frac{1000000}{Minimum\ Line\ Period}$$

The following table shows some possible FPS values, with the ADC End Range fixed to 8-bit, 10-bit and 12-bit.

**Figure 20:**  
**Sensor Speed Example for Different End of Range and Frequency Values**

End of Range	Frequency [MHz]	ADC Time [μs] + 1 μs	Readout Time [μs]	Minimum Line Period [μs]	Maximum Integration Time [μs]	FPS
12-Bit	80	52.2	13.2	52.2	50.2	19157
	20	205.8	52.6	205.8	203.8	4859
10-Bit	80	13.8	13.2	13.8	11.8	72464
	20	52.2	52.6	52.6	50.6	19011
8-Bit	80	4.2	13.2	13.2	11.2	76046
	20	13.8	52.6	52.6	50.6	19011

### 6.1.2 Companding Mode

When using the companding mode the ADC main clock calculations takes into consideration the thresholds registers and the ADC End of Range register.

**Equation 4:**

$$ADC\ Main\ Clock = \left[ Thres_1 + \frac{(Thres_2 - Thres_1)}{2} + \frac{(Thres_3 - Thres_2)}{4} + \frac{(EndADC - Thres_3)}{8} \right]$$

Where  $Thres_1$ ,  $Thres_2$  and  $Thres_3$  are the three thresholds registers, addresses 0x06, 0x07 and 0x08 respectively (all multiplied by 32).

When the companding mode is on it is important to have also the on-chip digital re-linearization activated (register 5 bit 1) to produce a linear sensor output and to enable dithering to avoid missing codes.

The three thresholds must have increasing values and smaller than the End Range value, otherwise the ADC will not work properly, resulting in strongly distorted output signals.

The following tables present the timing values to a companding mode example.

**Figure 21:**  
**Registers Configuration to Companding Mode Example**

Register Name	Threshold 1	Threshold 2	Threshold 3	ADC End of Range	ADC Main Clock
Register value (Hex)	1	4	10	7F	620

Figure 22:  
Dragster Timing Limits in Companding Mode

End of Range	Frequency [MHz]	ADC Time [ $\mu$ s] + 1 $\mu$ s	Readout Time [ $\mu$ s]	Minimum Line Period [ $\mu$ s]	Maximum Integration Time [ $\mu$ s]	FPS
12-Bit	80	8.75	13.2	13.2	11.15	76046
	20	32	52.6	52.6	50.6	19011

## 7 Table of Abbreviations

Figure 23:  
Table of Abbreviations

Abbreviation	Explanation
ADC	Analog to Digital Converter
CDS	Correlated Double Sampling
CL	Camera Link
CLK	Clock
CMOS	Complementary Metal Oxide Semiconductor
CVC	Charge to Voltage Converter
DC	Direct Current
DN	Digital Number
DR	Dragster
FPGA	Field-Programmable Gate Array
GND	Ground
IO	Input Output
JTAG	Joint Test Action Group
LED	Light-Emitting Diode
LVAL	Line Valid
MOSI	Master Out Slave In
OS	Operating System
PCB	Printed Circuit Board
RST	Reset
SCLK	Serial Clock
SPI	Serial Peripheral Interface
TTL	Transistor-Transistor Logic
USB	Universal Serial Bus
VHDL	VHSIC, Very High Speed Integrated Circuit Hardware Description Language

## 8 Revision Information

Changes from previous version to current revision v2-00	Page
Updated to ams template	
Added chapter 4 (Software Description)	18
Added chapter 5 (Live Image)	22

- Page and figure numbers for the previous version may differ from page and figure numbers in the current revision.
- Correction of typographical errors is not explicitly mentioned.

## 9 Legal Information

### Copyrights & Disclaimer

Copyright ams AG, Tobelbader Strasse 30, 8141 Premstaetten, Austria-Europe. Trademarks Registered. All rights reserved. The material herein may not be reproduced, adapted, merged, translated, stored, or used without the prior written consent of the copyright owner.

Demo Kits, Evaluation Kits and Reference Designs are provided to recipient on an "as is" basis for demonstration and evaluation purposes only and are not considered to be finished end-products intended and fit for general consumer use, commercial applications and applications with special requirements such as but not limited to medical equipment or automotive applications. Demo Kits, Evaluation Kits and Reference Designs have not been tested for compliance with electromagnetic compatibility (EMC) standards and directives, unless otherwise specified. Demo Kits, Evaluation Kits and Reference Designs shall be used by qualified personnel only.

ams AG reserves the right to change functionality and price of Demo Kits, Evaluation Kits and Reference Designs at any time and without notice.

Any express or implied warranties, including, but not limited to the implied warranties of merchantability and fitness for a particular purpose are disclaimed. Any claims and demands and any direct, indirect, incidental, special, exemplary or consequential damages arising from the inadequacy of the provided Demo Kits, Evaluation Kits and Reference Designs or incurred losses of any kind (e.g. loss of use, data or profits or business interruption however caused) as a consequence of their use are excluded.

ams AG shall not be liable to recipient or any third party for any damages, including but not limited to personal injury, property damage, loss of profits, loss of use, interruption of business or indirect, special, incidental or consequential damages, of any kind, in connection with or arising out of the furnishing, performance or use of the technical data herein. No obligation or liability to recipient or any third party shall arise or flow out of ams AG rendering of technical or other services.

### RoHS Compliant & ams Green Statement

**RoHS Compliant:** The term RoHS compliant means that ams AG products fully comply with current RoHS directives. Our semiconductor products do not contain any chemicals for all 6 substance categories plus additional 4 substance categories (per amendment EU 2015/863), including the requirement that lead not exceed 0.1% by weight in homogeneous materials. Where designed to be soldered at high temperatures, RoHS compliant products are suitable for use in specified lead-free processes.

**ams Green (RoHS compliant and no Sb/Br/Cl):** ams Green defines that in addition to RoHS compliance, our products are free of Bromine (Br) and Antimony (Sb) based flame retardants (Br or Sb do not exceed 0.1% by weight in homogeneous material) and do not contain Chlorine (Cl) not exceed 0.1% by weight in homogeneous material).

**Important Information:** The information provided in this statement represents ams AG knowledge and belief as of the date that it is provided. ams AG bases its knowledge and belief on information provided by third parties, and makes no representation or warranty as to the accuracy of such information. Efforts are underway to better integrate information from third parties. ams AG has taken and continues to take reasonable steps to provide representative and accurate information but may not have conducted destructive testing or chemical analysis on incoming materials and chemicals. ams AG and ams AG suppliers consider certain information to be proprietary, and thus CAS numbers and other limited information may not be available for release.

### Headquarters

ams AG  
Tobelbader Strasse 30  
8141 Premstaetten  
Austria, Europe  
Tel: +43 (0) 3136 500 0

Please visit our website at [www.ams.com](http://www.ams.com)

Buy our products or get free samples online at [www.ams.com/Products](http://www.ams.com/Products)

Technical Support is available at [www.ams.com/Technical-Support](http://www.ams.com/Technical-Support)

Provide feedback about this document at [www.ams.com/Document-Feedback](http://www.ams.com/Document-Feedback)

For sales offices, distributors and representatives go to [www.ams.com/Contact](http://www.ams.com/Contact)

For further information and requests, e-mail us at [ams\\_sales@ams.com](mailto:ams_sales@ams.com)